

## Plastic Pressure Systems



## Plastic Pressure Systems



Price List 2021

**Polypipe Effast**

New Hythe Business Park  
College Road  
Aylesford  
Kent, ME20 7PJ  
Tel: +44 1622 795225  
Effast@polypipe.com  
www.polypipe.com

# Welcome to Effast

Effast by Polypipe, is a well-established brand name that is recognised throughout both the industrial process market and construction industries for its market-leading range of thermoplastic pipework systems. Specialist in PVC and ABS materials, Effast's comprehensive product portfolio offers a proven and effective solution to virtually any requirement. No matter what the project, the Effast range can offer the perfect combination of pressure pipe fittings, ball, butterfly, diaphragm and actuated valves, compression joints, adaptors and other fittings.

Through experience and expertise, we have a detailed understanding of the complexity of our customer's projects, the challenges that can arise and the applications in which our systems are used. Therefore, working within these environments and understanding the regulations required we are able to deliver sustainable pressure systems to applications such as; food and beverage processing, water treatment, marine, spa and swimming pools, mining, building technology and agriculture.

Manufactured in the Cicagna region of Italy, Effast pressure systems are sold to over 60 countries around the world, delivered through a vast distribution network meaning products are readily available, even when needed next day.

Supported by our large UK based manufacturing capabilities, Polypipe leads the way in the research and development of advanced new solutions that satisfy the specific needs of the market, developing patents for our specialist products along the way.

We take our standards seriously and invest in ensuring relevant approvals for all our products where possible – providing outstanding performance, reliability and the quality you expect from a brand like Effast. Ensuring we deliver quality, sustainable products and services means a great deal to us, our supply chain and our customers – and has been recognised with ISO 9001 & ISO 14001 accreditations.

We strive to ensure the generation of waste – both of plastic and other materials – is minimised, to help develop a sustainable, low carbon, resource-efficient service. We don't just recycle all our in-process material waste; we monitor every process and adjust the smallest thing to make a bigger difference, whether raw material, electricity or water.

Dedicated to supporting our customers at every stage, our sales and technical support teams are fully trained on our products, systems, processes, the latest performance requirements, regulations and legislation to be able to provide the best solutions for your project. Investing in our people remains at the core of our business strategy which is why our team focus on delivering a service which stays true to our values; Trust, Support, Experience and Innovation.

We invest heavily in marketing, providing all the technical support you need from design guides, technical drawings and data sheets to BIM modelling and everything in between.

Get in touch and find out how we can support you on your next project.

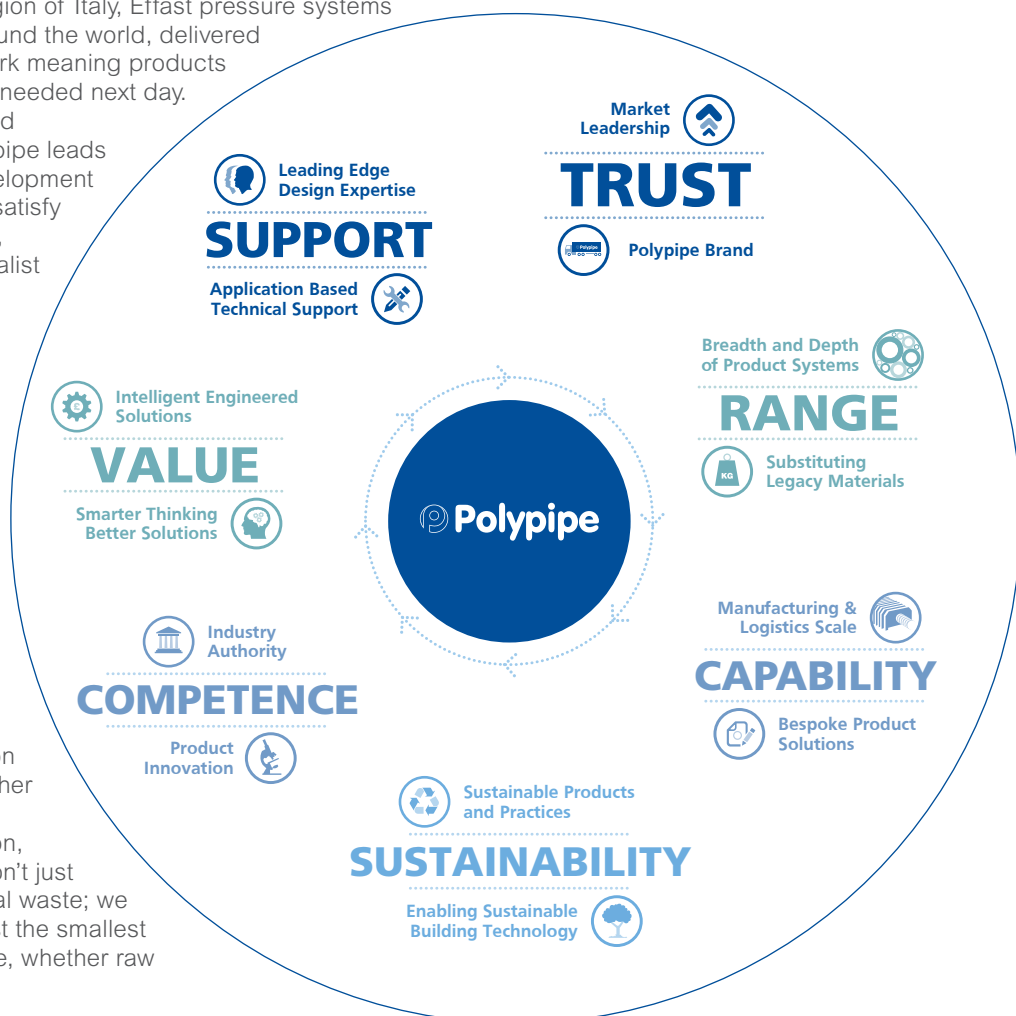

**EFFAST**

Performance Under Pressure

\*see back page for contact details

\*For more information on all the relevant accreditations please visit our website [www.effast.com](http://www.effast.com)

# Contents

Product Comparison	4
Effast Quality Certifications	5

## PVC-u 6-100

PVC-u Introduction	6 - 7
<b>PVC-u Pipes &amp; Fittings</b>	<b>8 - 54</b>
PVC-u Pipes Imperial and Metric	8 - 15
PVC-u Solvent Cement Fittings Imperial	16 - 20
PVC-u Flanges Imperial	21 - 23
PVC-u Adaptor Fittings Imperial	24 - 29
PVC-u Threaded Fittings Imperial	30 - 36
PVC-u Solvent Cement Fittings Metric	37 - 45
PVC-u Flanges Metric	46 - 47
PVC-u Adaptor Fittings Metric	48 - 54

## PVC-u Valves 55 - 100

PVC-u Industrial Ball Valves Manual Imperial, Metric and Threaded Imperial	56 - 63
PVC-u Water Supply Manual Ball Valves Imperial, Metric and Threaded Imperial	64 - 68
PVC-u Water Supply Single Union Manual Ball Valves Imperial, Metric and Threaded Imperial	69 - 73
PVC-u 3 Way Industrial Manual Ball Valves Imperial and Metric	74
PVC-u Check Valves Imperial, Metric and Threaded Imperial	75 - 82
PVC-u Wafer Check Valves	83 - 84
PVC-u Air Release Valve & Foot Valve Imperial, Metric and Threaded Imperial	85 - 87
PVC-u Diaphragm Valves and Pressure Reducer Valves Imperial, Metric and Threaded Imperial	88 - 90
PVC-u PROFLOW Butterfly Valves Imperial and Metric	91 - 97
PVC-u Flowmeter	98 - 100

## ABS 101 - 131

ABS Introduction	101 - 102
<b>ABS Pipes &amp; Fittings</b>	<b>103 - 122</b>
ABS Pipes Imperial	104 - 105
ABS Solvent Cement Fittings Imperial	106 - 110
ABS Flanges Imperial	111 - 112
ABS Adaptor Fittings Imperial	113 - 118
ABS Threaded Fittings Imperial	119 - 122

## ABS Valves 123 - 131

ABS Industrial Manual Ball Valves	123 - 126
ABS Auxiliary and Check Valves	127 - 128
ABS Check Valve & Air Release Valve	129 - 131

## Actuated Valves 132 - 142

Actuated Valves Introduction	132 - 133
<b>Actuated Double Union Industrial Ball Valves</b>	<b>134 - 139</b>
PVC-u Electrically Actuated Double Union Industrial Ball Valves Imperial and Metric	134 - 135
PVC-u Pneumatically Actuated Double Union Industrial Ball Valves Imperial and Metric	136 - 137
ABS Electrically Actuated Double Union Industrial Ball Valves Imperial and Metric	138 - 139
<b>Actuated Butterfly Valves</b>	<b>140 - 142</b>
PVC-u Electrically Actuated Butterfly Valves Metric	140
PVC-u Pneumatically Actuated Butterfly Valves Metric	141 - 142

## Accessories 143 - 152



Backing Rings	144
Gaskets	145
Pipe Clips, Clamps & Brackets	146
Solvent Cement & PTFE Tape	147
PVC-u & ABS Valve Spares	148 - 150
PVC-u & ABS Union Spares	150 - 152

## Technical Information 153 - 157

Guide to Solvent Jointing	153 - 154
Guide to Chemical Resistance	155 - 159

Polypipe is the UK's largest manufacturer of sustainable water and climate management solutions for the built environment. Offering over 20,000 product lines through 18 facilities across the UK, Europe and Middle East, Polypipe has an unrivalled portfolio of innovative solutions. Operating through sector focused businesses Polypipe ensures our sales and technical teams are equipped to meet the specific needs of residential, civils & green urbanisation, commercial and industrial projects.

# Product comparison

	PVCu	Typical Applications
	Most Widely Used Plastic Material	Industrial Process Systems
	Large Choice of Fittings	Water Treatment and Chemical Dosing
	Excellent Chemical Resistance	Food & Beverage
	Rigid Construction	Swimming Pools and Spas
		Cold Water Supply
	ABS	
	Wide Temperature Range	Chilled Water
	High Impact Strength	Boosted Cold Water
	Abrasion Resistance	Plant Rooms
	Non Toxic	Chemical & Pharmaceutical

Guide to Chemical Resistance available pages 155 - 159

## General overview and comparison of the TWO system materials

Material	Sizes available	Minimum operating temperature	Maximum operating temperature	Joining methods†	Colour
PVCu	Metric 16mm - 315mm Imperial ½" - 8"	0°C	60°C	Solvent Weld	Dark grey
ABS	Imperial ½" - 8"	-40°C	60°C	Solvent Weld	Light grey

The operating pressure of plastics is reduced with increases in operating temperature.

† A range of flanges and threaded fittings are available within all systems.

All Effast materials are suitable for a number of applications. The table below details common applications and the appropriate Effast materials for that situation

Applications Guide	ABS	PVCu	Applications Guide	ABS	PVCu	Applications Guide	ABS	PVCu
Acids and Alkalis	✓	✓	Effluent Treatment	✓		Potable Water	✓	✓
A/C and Refrigeration	✓		Electro Plating	✓	✓	Pulp and Paper	✓	
Biotechnology	✓	✓	Film Processing	✓	✓	Semi Conductor	✓	✓
Boosted Cold Water	✓	✓	Food Processing & Beverages	✓		Slurries	✓	
Condensate	✓		Glycol Systems	✓		Swimming Pools	✓	✓
Chemical Dosing	✓	✓	Irrigation	✓	✓	Water & Sewage Treatments	✓	✓
Chilled Water	✓		Marine / Brine	✓		Water Industry	✓	✓
De-Mineralised Water	✓	✓	Pharmaceutical	✓	✓			

# Effast Quality Certifications

Our technical experience in product innovation helps us to have a range of products that are always kept up to date and in line with all the latest international standards. For this reason, the quality of the Effast product is the most prestigious in the international field and cover both technical standards and permits for use with drinking water and food fluids according to the regulations in force in various countries.

**kiwa** 

**IT-TD-Ki0410**  
KIP 088883  
UNI EN ISO 1452-3:2010-12  
KIP 088883/01

**kiwa** 

BRL-K 17301  
K 21166/05



NF EN 1452; NF T 54-029  
63-1-P-18



EN 1452-3:2010-12  
CW 8621 – CQ0141



BS EN 1452-3:2010:2012  
KM 60041  
BS 5392-1:2006 pt.1  
KM 60042



GHOST  
C-IT.04.B.00412



**BUREAU VERITAS**

BV  
Type Approval  
N° 37693 / A0 – A1 BV



Certificate n° 2005001,  
1703070, 1907503, 1705075,  
1702558, 1702558, 2010508,  
2001563  
(up to and including 4" pipe)

**KTW**

KTW GUIDELINE  
KIWA 17-K-108



ACS (Attestation de  
Conformité Sanitaire)  
14 MALTU 175-176  
15 ACCLY 400



Certified to  
NSF/ANSI/CAN 61

NSF/ANSI 61  
C0337655



1115 EU dir 2014/68/EU  
n° 508PED93001A2

All descriptions and illustrations in this publication are intended for guidance only and shall not constitute a 'sale by description'. All dimensions given are nominal, while changes can be done on the information, products and specifications from time to time for a variety of reasons, without prior notice. The information in this publication is provided 'as is' on the revision date stated on the sheet. Updates will not be issued automatically. This information is not intended to have any legal effect, whether by way of advice, representation or warranty (express or implied). We accept no liability whatsoever (to the extent permitted by law) if you place any reliance on this publication you must do so at your own risk. All rights reserved. Copyright in this publication belongs to Polypipe and all such copyright may not be used, sold, copied or reproduced in whole or part in any manner in any media to any person without prior consent. **EFFAST** is a registered trademark.





## PVC-u

# PVC-u Valves, Pipes & Fittings

## PVC-u Valves, Pipes & Fittings

Unplasticised polyvinyl chloride (PVC-u) is one of the most widely used thermoplastic materials for pipe installations.

Being odourless and tasteless it is suitable for conveying potable water and many food products. PVC-u has excellent chemical resistance.

The good flow characteristics are the result of the smooth bore and it has good resistance to abrasion.

It is light in weight, easy to join together making PVC-u a good alternative to the more traditional materials.

PVC-u is resistant to most solutions of acids, alkalis, salts and solvents that can be mixed with water.

Additional information in this respect can be obtained from our Technical Department or by reading the Guide to Chemical Resistance at the end of this book.

## Materials

Effast PVC-u is stabilised with compounds conforming to the EEC safety levels for vinyl chloride monomer (VCM) and the WRAS requirements for use with potable water.

## Colour

PVC-u products are recognised by their dark grey colour RAL 7035.

## Chemical Resistance

The chemical resistance properties of PVC-u are excellent: it is resistant to most solutions of acids, alkalis and salts and to solvents that can be mixed with water. PVC-u is not resistant to aromatic and chlorinated hydrocarbons.

## Thermal Expansion

The thermal coefficient of linear expansion for PVC-u is  $7.8 \times 10^{-5}$  m/m °C

It is necessary in certain situations to make special provision for the expansion and contraction.

Thermal expansion of PVC-u is compared with other materials in the following chart:

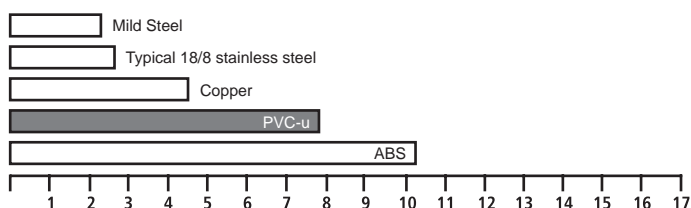

## Temperature range

0 °C ÷ +60 °C

## Standards for Valves

- UNI EN ISO 1452  
Plastics piping systems for water supply and for buried and above-ground drainage and sewerage under pressure – Unplasticized poly(vinyl chloride) (PVC-U).
- EN ISO 15493  
Plastics piping systems for industrial applications – Acrylonitrile-butadiene-styrene (ABS), unplasticized poly(vinyl chloride) (PVC-U) and chlorinated poly(vinyl chloride) (PVC-C) – Specifications for components and the system – Metric series.
- UNI 11242  
Welding – Welding of plastics – Adhesive bonding of PVC-U, PVC-C and ABS pipes, fittings and valves for transmission lines of fluids with or without pressure.
- BS 4346-1  
Specification for Joints and fittings for use with unplasticized PVC pressure pipes. Part 1: Injection moulded unplasticized PVC fittings for solvent welding for use with pressure pipes, including potable water supply.
- DIN 8062  
PVC-U pipes dimensions.
- ASTM D 2467  
Standard Specification for Poly (Vinyl Chloride) (PVC) Plastic Pipe Fittings. Schedule 80.
- JIS K 6743  
Unplasticized poly(vinyl chloride) (PVC-U) pipe fittings for water supply.
- JIS K 6741  
PVC-U pipes.
- UNI EN 10226-1  
Pipe threads where pressure tight joints are made on the threads – Part 1: Taper external threads and parallel internal threads – Dimensions, tolerances and designation.
- DIN EN 10226-3  
Pipes threads where pressure tight joints are made on the threads – Part 3: Verification by means of limit gauges.
- ISO 9393  
Thermoplastics valves for industrial applications – Pressure test methods and requirements – Test conditions and basic requirements.
- EN ISO 16135  
Industrial valves – Ball valves of thermoplastics materials.
- EN ISO 16136  
Industrial valves – Butterfly valves of thermoplastics materials.
- EN ISO 16137  
Industrial Valves – Check Valves of thermoplastic materials.
- EN ISO 16138  
Industrial valves-Diaphragm valves of thermoplastic materials.
- EN 558-1  
Industrial valves-Face-to-face and center-to-face dimensions of metal valves for use in flanged pipe systems – Part 1: PN-designated valves.
- DIN EN 558  
Industrial valves – Face-to-face and centre-to-face dimensions of metal valves for use in flanged pipe systems – PN and Class designated valves.
- UNI EN ISO 5211  
Industrial valves – Part-turn actuator attachments.

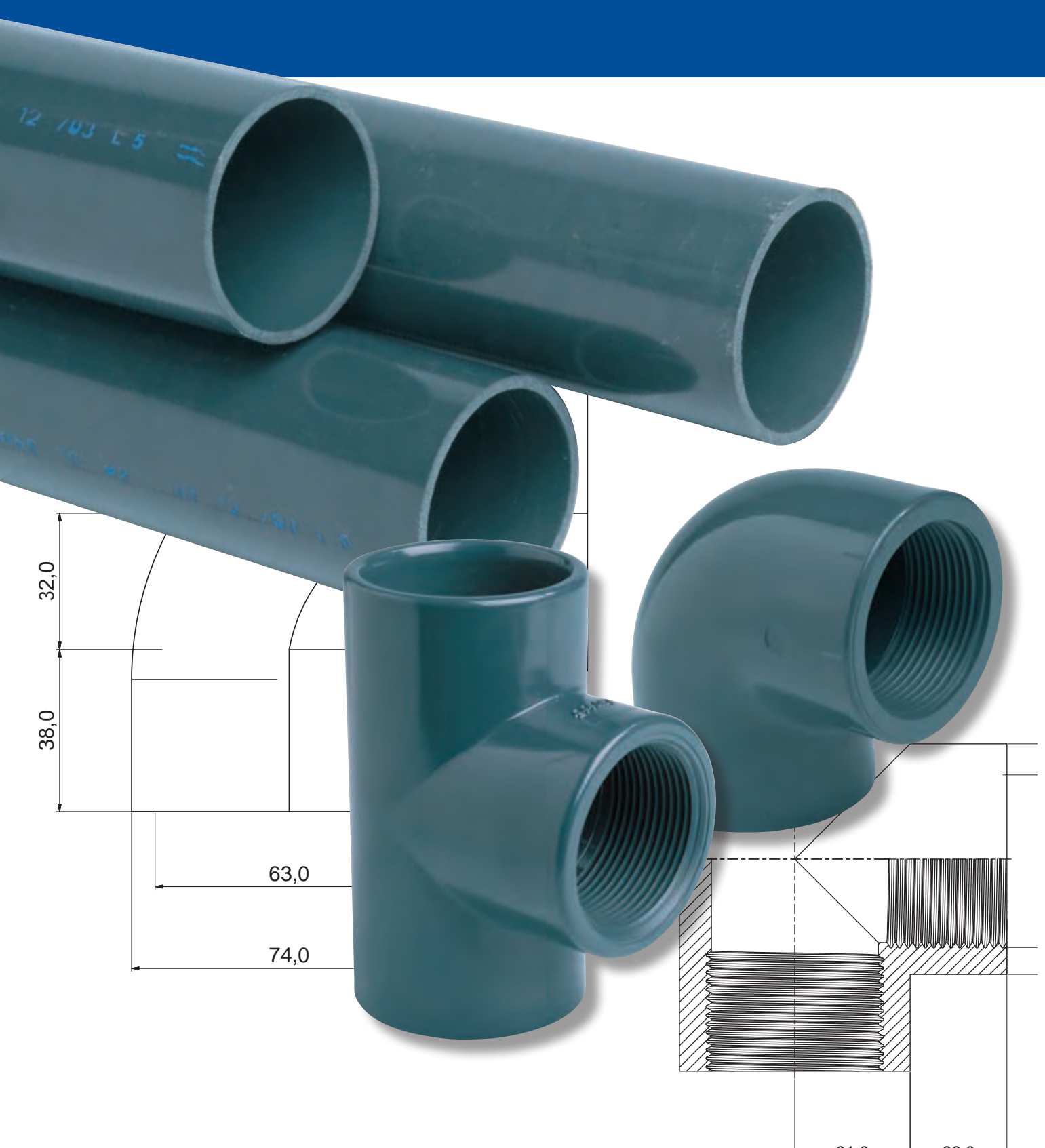

## PVC-u, Pipes & Fittings

---



# PVC-u, Pipes & Fittings

## Imperial and Metric Sizes

The following notes may be helpful to those unfamiliar with the different ways of describing metric and imperial sizes when specifying pipe or fittings.

When specifying imperial pipe fittings and other components reference is made to the nominal size of the pipe bore in inches and fractions of an inch.

Metric Systems are specified by reference to the outside diameter of the pipe expressed in millimetres.

As a general guide the following table gives a comparison between metric and imperial sizes up to 8 inches. It is important to understand that metric sizes are not simply inch sizes which have been converted into millimetres and called metric. The actual equivalents are slightly different (except for Imperial size 2½" and metric size 75mm and 5 inches and 140 mm which happen to coincide exactly) and are not interchangeable.

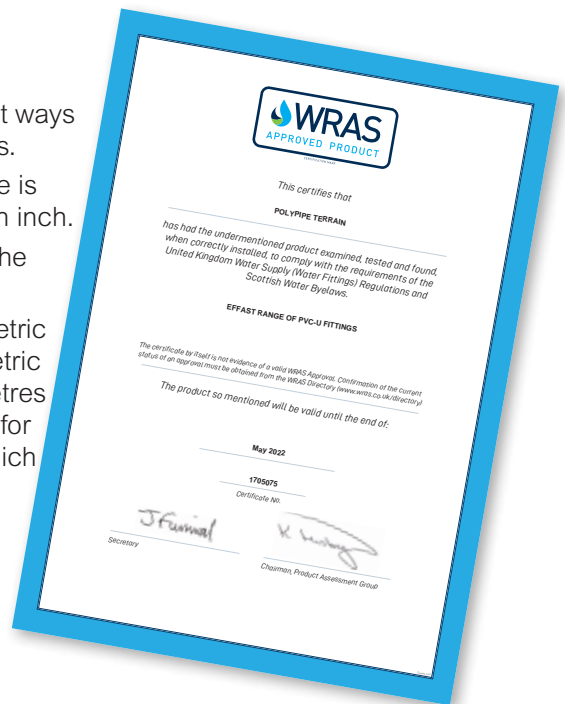

Imperial size (inches)		Metric size (mm)	
Nominal bore	Pipe outside diameter	Pipe outside diameter	Nominal bore
⅜"	17.1	16	10
½"	21.4	20	15
¾"	26.7	25	20
1"	33.6	32	25
1¼"	42.2	40	32
1½"	48.3	50	40
2"	60.3	63	50
2½"	75.2	75	65
3"	88.9	90	80
4"	114.3	110	100
5"	140.2	140	125
6"	168.3	160	150
8"	219.1	225	200



Average Wall Thickness (mm) for Metric Pipe		
Diameter (mm)	Average Wall Thickness (mm)	
Outside diameter	10 bar	16 bar
16	–	1.2
20	–	1.5
25	1.5	1.9
32	1.6	2.4
40	1.9	3.0
50	2.4	3.7
63	3.0	4.7
75	3.6	5.6
90	4.2	6.6
110	4.3	6.7
125	4.8	7.4
140	5.4	8.3
160	6.2	9.5
180	6.9	10.7
200	7.7	11.9
225	8.6	13.4
250	9.6	14.8
280	10.7	16.6
315	12.1	18.7

Average Wall Thickness for Imperial Pipe										
Diameter	Wall thickness (mm)									
Nominal size (inch)	Class C 9.0 bar			Class D 12.0 bar			Class E 15.0 bar			Class 7 12.0 bar
	Average	Min	Max	Average	Min	Max	Average	Min	Max	Average
3/8"	–	–	–	–	–	–	1.9	1.5	1.9	–
1/2"	–	–	–	–	–	–	2.1	1.7	2.1	4.0
3/4"	–	–	–	–	–	–	2.5	1.9	2.5	4.2
1"	–	–	–	–	–	–	2.7	2.2	2.7	4.8
1 1/4"	–	–	–	2.7	2.2	2.7	3.2	2.7	3.2	5.2
1 1/2"	–	–	–	3.0	2.5	3.0	3.7	3.1	3.7	5.5
2"	3.0	2.5	3.0	3.7	3.1	3.7	4.5	3.9	4.5	5.9
2 1/2"	3.6	–	–	–	–	–	5.6	–	–	–
3"	4.1	3.5	4.1	5.3	4.6	5.3	6.5	5.7	6.6	–
4"	5.2	4.5	5.2	6.8	6.0	6.9	8.3	7.3	8.4	–
5"	6.3	5.5	6.4	8.3	7.3	8.4	10.1	9.0	10.4	–
6"	7.5	6.6	7.6	9.9	8.8	10.2	12.1	10.8	12.5	–
8"	8.8	7.8	9.0	11.6	10.3	11.9	14.1	12.6	14.5	–
10"	10.9	9.7	11.2	14.3	12.8	14.8	17.5	15.7	18.1	–
12"	12.9	11.5	13.3	17.0	15.2	17.5	20.8	18.7	21.6	–

Temperature and Pressure Relationship for PVCu Pipes					
	Class C	Class D	Class E	PN10	PN16
Temperature (°C)	Bar (psi)	Bar (psi)	Bar (psi)	Bar	Bar
0	9.0 (130)	12.0 (174)	15.0 (217)	10.0	16.0
20	9.0 (130)	12.0 (174)	15.0 (217)	10.0	16.0
30	8.1 (117)	10.8 (156)	13.5 (195)	8.0	12.8
40	6.3 (91)	8.4 (121)	10.5 (152)	6.4	10.2
50	4.0 (58)	5.4 (78)	6.7 (97)	4.4	7.0
60	1.3 (18)	1.8 (26)	2.2 (31)	2.6	4.1

## PVC-u Pressure Pipe 3m Plain End Imperial

**PSPVP**

**PVC-u Pressure Pipe Imperial**  
Pressure Pipe Class C - 3 Metre (9 Bar at 20°C)

Nominal size (d)	Code	Price per metre	Price each
2"	RPCCLC0630PE3	£9.90	£29.70
2 1/2"	RPCCLC0750PE3	£14.59	£43.78
3"	RPCCLC0900PE3	£19.24	£57.72
4"	RPCCLC1100PE3	£30.27	£90.80
5"	RPCCLC1400PE3	£45.00	£134.99
6"	RPCCLC1600PE3	£69.11	£207.34
8"	RPCCLC2250PE3	£104.08	£312.24



## PSPVP

**PVC-u Pressure Pipe Imperial**  
Pressure Pipe Class D - 3 Metre (12 Bar at 20°C)

Nominal size (d)	Code	Price per metre	Price each
1¼"	RPDCLD0400PE3	£6.07	£18.20
1½"	RPDCLD0500PE3	£7.78	£23.34
2"	RPDCLD0630PE3	£11.34	£34.02
3"	RPDCLD0900PE3	£24.52	£73.56
4"	RPDCLD1100PE3	£39.42	£118.26
6"	RPDCLD1600PE3	£84.60	£253.80



## PSPVP

**PVC-u Pressure Pipe Imperial**  
Pressure Pipe Class E - 3 Metre (15 Bar at 20°C)

Nominal size (d)	Code	Price per metre	Price each
½"	RPECLE0200PE3	£2.55	£7.64
¾"	RPECLE0250PE3	£3.62	£10.86
1"	RPECLE0320PE3	£4.66	£13.97
1¼"	RPECLE0400PE3	£7.28	£21.85
1½"	RPECLE0500PE3	£9.48	£28.43
2"	RPECLE0630PE3	£13.63	£40.88
2½"	RPECLE0750PE3	£21.95	£65.86
3"	RPECLE0900PE3	£29.78	£89.35
4"	RPECLE1100PE3	£47.01	£141.02
6"	RPECLE1600PE3	£101.46	£304.38

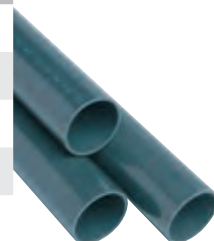

## PSPVP

**PVC-u Pressure Pipe Imperial**  
Pressure Pipe Class 7 Machining Quality - 3 Metre (12 Bar at 20°C)

Nominal size (d)	Code	Price per metre	Price each
½"	RP7CL70200PE3	£5.82	£17.45
¾"	RP7CL70250PE3	£7.88	£23.63
1"	RP7CL70320PE3	£11.20	£33.59
1¼"	RP7CL70400PE3	£15.59	£46.77
1½"	RP7CL70500PE3	£19.02	£57.07
2"	RP7CL70630PE3	£25.96	£77.89



# PVC-u Pressure Pipe 3m Plain End Metric

**PSPVP**
**PVC-u Pressure Pipe Metric**  
 Pressure Pipe PN10 - 3 Metre (10 Bar at 20°C)

Nominal size (d)	Code	Price per metre	Price each
40mm	RP10CL100400PE3	£6.48	£19.44
50mm	RP10CL100500PE3	£9.54	£28.61
63mm	RP10CL100630PE3	£10.64	£31.91
75mm	RP10CL100750PE3	£15.16	£45.47
90mm	RP10CL100900PE3	£21.08	£63.23
110mm	RP10CL101100PE3	£30.88	£92.64
125mm	RP10CL101250PE3	£42.83	£128.49
140mm	RP10CL101400PE3	£45.00	£134.99
160mm	RP10CL101600PE3	£65.55	£196.64
200mm	RP10CL102000PE3	£110.30	£330.89
225mm	RP10CL102250PE3	£138.89	£416.67
250mm	RP10CL102500PE3	£186.44	£559.31
280mm	RP10CL102800PE3	£208.39	£625.18
315mm	RP10CL103150PE3	£270.30	£810.91

**PSPVP**
**PVC-u Pressure Pipe Metric**  
 Pressure Pipe PN16 - 3 Metre (16 Bar at 20°C)

Nominal size (d)	Code	Price per metre	Price each
16mm	RP16CL160160PE3	£1.39	£4.16
20mm	RP16CL160200PE3	£1.99	£5.97
25mm	RP16CL160250PE3	£3.11	£9.33
32mm	RP16CL160320PE3	£4.95	£14.86
40mm	RP16CL160400PE3	£7.73	£23.19
50mm	RP16CL160500PE3	£11.84	£35.52
63mm	RP16CL160630PE3	£15.97	£47.90
75mm	RP16CL160750PE3	£22.60	£67.80
90mm	RP16CL160900PE3	£32.20	£96.60
110mm	RP16CL161100PE3	£46.74	£140.22
160mm	RP16CL161600PE3	£98.21	£294.62





# PVC-u Pressure Pipe 6m Plain End Imperial

## PSPVP

**PVC-u Pressure Pipe Imperial**  
Pressure Pipe Class C - 6 Metre (9 Bar at 20°C)

Nominal size (d)	Code	Price per metre	Price each
2"	RPCCLC0630PE	£9.90	£59.42
2½"	RPCCLC0750PE	£14.59	£87.52
3"	RPCCLC0900PE	£19.24	£115.45
4"	RPCCLC1100PE	£30.27	£181.60
5"	RPCCLC1400PE	£44.99	£269.97
6"	RPCCLC1600PE	£69.11	£414.69
8"	RPCCLC2250PE	£104.08	£624.50

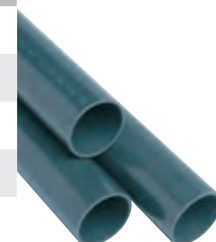

## PSPVP

**PVC-u Pressure Pipe Imperial**  
Pressure Pipe Class D - 6 Metre (12 Bar at 20°C)

Nominal size (d)	Code	Price per metre	Price each
1¼"	RPDCLD0400PE	£6.06	£36.38
1½"	RPDCLD0500PE	£7.78	£46.67
2"	RPDCLD0630PE	£11.34	£68.05
3"	RPDCLD0900PE	£24.52	£147.11
4"	RPDCLD1100PE	£39.42	£236.52
6"	RPDCLD1600PE	£84.60	£507.58

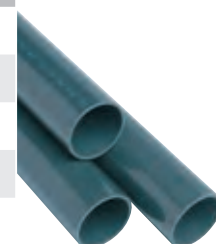

## PSPVP

**PVC-u Pressure Pipe Imperial**  
Pressure Pipe Class E - 6 Metre (15 Bar at 20°C)

Nominal size (d)	Code	Price per metre	Price each
½"	RPECLE0200PE	£2.55	£15.28
¾"	RPECLE0250PE	£3.62	£21.69
1"	RPECLE0320PE	£4.66	£27.93
1¼"	RPECLE0400PE	£7.28	£43.66
1½"	RPECLE0500PE	£9.48	£56.85
2"	RPECLE0630PE	£13.63	£81.78
2½"	RPECLE0750PE	£21.96	£131.74
3"	RPECLE0900PE	£29.78	£178.69
4"	RPECLE1100PE	£47.01	£282.03
6"	RPECLE1600PE	£101.45	£608.72

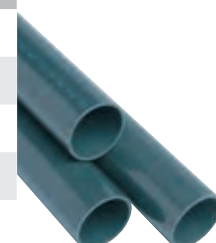

## PSPVP

**PVC-u Pressure Pipe Imperial**  
 Pressure Pipe Class 7 Machining Quality - 6 Metre (12 Bar at 20°C)

PVCu - Pipe

Nominal size (d)	Code	Price per metre	Price each
½"	RP7CL70200PE	£5.81	£34.87
¾"	RP7CL70250PE	£7.88	£47.27
1"	RP7CL70320PE	£11.19	£67.14
1¼"	RP7CL70400PE	£15.60	£93.58
1½"	RP7CL70500PE	£19.03	£114.16
2"	RP7CL70630PE	£25.97	£155.80



## PVC-u Pressure Pipe 6m Plain End Metric

**PSPVP**

**PVC-u Pressure Pipe Metric**  
Pressure Pipe PN10 - 6 Metre (10 Bar at 20°C)

Nominal size (d)	Code	Price per metre	Price each
40mm	RP10CL100400PE	£6.48	£38.91
50mm	RP10CL100500PE	£9.53	£57.16
63mm	RP10CL100630PE	£10.63	£63.80
75mm	RP10CL100750PE	£15.16	£90.98
90mm	RP10CL100900PE	£21.08	£126.45
110mm	RP10CL101100PE	£30.88	£185.30
125mm	RP10CL101250PE	£42.82	£256.94
140mm	RP10CL101400PE	£45.26	£271.58
160mm	RP10CL101600PE	£65.55	£393.27
200mm	RP10CL102000PE	£110.29	£661.77
225mm	RP10CL102250PE	£138.90	£833.39
250mm	RP10CL102500PE	£186.43	£1,118.58
280mm	RP10CL102800PE	£208.39	£1,250.35
315mm	RP10CL103150PE	£270.31	£1,621.83

**PSPVP**

**PVC-u Pressure Pipe Metric**  
Pressure Pipe PN16 - 6 Metre (16 Bar at 20°C)

Nominal size (d)	Code	Price per metre	Price each
16mm	RP16CL160160PE	£1.40	£8.38
20mm	RP16CL160200PE	£2.00	£11.98
25mm	RP16CL160250PE	£3.11	£18.66
32mm	RP16CL160320PE	£4.95	£29.68
40mm	RP16CL160400PE	£7.73	£46.38
50mm	RP16CL160500PE	£11.84	£71.04
63mm	RP16CL160630PE	£15.96	£95.75
75mm	RP16CL160750PE	£22.60	£135.58
90mm	RP16CL160900PE	£32.20	£193.21
110mm	RP16CL161100PE	£46.74	£280.44
160mm	RP16CL161600PE	£98.22	£589.29

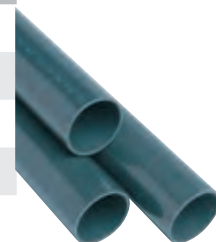

# PVC-u Solvent Cement Fittings Imperial

**PSPVF**
**Solvent Welded Fittings Imperial**  
 Socket Plain

Nominal size (d)	Code	L	Z	E	PN	Price each
3/8"	RFAMAA0160	15	3	23	15	£2.08
1/2"	RFAMAA0200	17	3	27	15	£2.35
3/4"	RFAMAA0250	20	3	33	15	£2.62
1"	RFAMAA0320	23	3	41	15	£3.05
1 1/4"	RFAMAA0400	27	3	50	15	£5.42
1 1/2"	RFAMAA0500	32	3	61	15	£6.37
2"	RFAMAA0630	38	3	76	15	£9.01
2 1/2"	RFAMAA0750	44	3	90	15	£19.08
3"	RFAMAA0900	51	5	110	15	£34.41
4"	RFAMAA1100	63	6	133	15	£50.04
5"	RFAMAA1400	76	8	161	15	£99.32
6"	RFAMAA1600	90	8	198	15	£126.59
8"	RFAMAA2250	119	11	258	9	£381.97

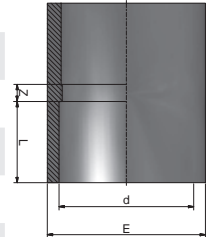
**PSPVF**
**Solvent Welded Fittings Imperial**  
 Union Plain

Nominal size (d)	Code	L	Z	H	E	F	PN	Price each
3/8"	RFABOA0160	14	14	42	34	3/4"	15	£10.12
1/2"	RFABOA0200	16	13	45	43	1"	15	£12.12
3/4"	RFABOA0250	19	13	51	54	1 1/4"	15	£13.83
1"	RFABOA0320	22	13	57	60	1 1/2"	15	£17.88
1 1/4"	RFABOA0400	27	14	68	75	2"	15	£22.34
1 1/2"	RFABOA0500	31	18	80	81	2 1/4"	15	£30.51
2"	RFABOA0630	38	22	98	99	2 3/4"	15	£47.93
2 1/2"	RFABOA0750	44	22	110	120	3 1/2"	15	£133.73
3"	RFABOA0900	51	23	125	134	4"	15	£166.87
4"	RFABOA1100	61	23	145	163	5"	15	£198.86

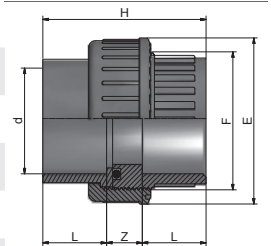



**PSPVF**

**Solvent Welded Fittings Imperial**  
Elbow 90° Plain

Nominal size (d)	Code	L	Z	E	PN	Price each
3/8"	RFAGOA0160	15	9	23	15	£2.72
1/2"	RFAGOA0200	17	11	27	15	£3.17
3/4"	RFAGOA0250	20	14	33	15	£3.65
1"	RFAGOA0320	23	17	41	15	£5.15
1 1/4"	RFAGOA0400	27	23	51	15	£9.01
1 1/2"	RFAGOA0500	32	28	61	15	£11.60
2"	RFAGOA0630	38	34	75	15	£17.28
2 1/2"	RFAGOA0750	44	40	89	15	£32.44
3"	RFAGOA0900	52	48	106	15	£49.79
4"	RFAGOA1100	63	58	133	15	£74.83
5"	RFAGOA1400	76	72	164	15	£171.36
6"	RFAGOA1600	90	81	198	15	£295.73
8"	RFAGOA2250	119	115	258	9	£701.05

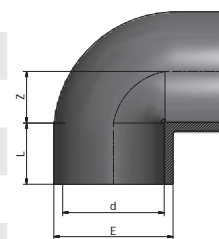

PVCu - Imperial

**PSPVF**

**Solvent Welded Fittings Imperial**  
Elbow 45° Plain

Nominal size (d)	Code	L	Z	E	PN	Price each
3/8"	RFAGYA0160	15	6	23	15	£5.15
1/2"	RFAGYA0200	17	5	27	15	£5.97
3/4"	RFAGYA0250	20	6	33	15	£6.22
1"	RFAGYA0320	23	8	41	15	£7.63
1 1/4"	RFAGYA0400	27	10	50	15	£10.85
1 1/2"	RFAGYA0500	32	12	61	15	£13.72
2"	RFAGYA0630	38	15	75	15	£19.25
2 1/2"	RFAGYA0750	44	18	89	15	£30.23
3"	RFAGYA0900	52	21	106	15	£45.41
4"	RFAGYA1100	63	25	133	15	£93.20
5"	RFAGYA1400	76	32	164	15	£158.89
6"	RFAGYA1600	90	36	198	15	£193.81
8"	RFAGYA2250	119	49	258	9	£642.44

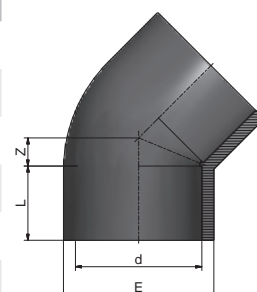

## PSPVF

### Solvent Welded Fittings Imperial Bend 90° Short Radius Plain

Nominal size (d)	Code	L	Z	E	PN	Price each
½"	RFACUA0200	16	40	28	15	£11.71
¾"	RFACUA0250	20	49	33	15	£21.09
1"	RFACUA0320	22	64	42	15	£25.62
1¼"	RFACUA0400	26	80	51	15	£40.11
1½"	RFACUA0500	31	100	63	15	£50.77
2"	RFACUA0630	38	126	77	15	£69.30
2½"	RFACUA0750	44	150	94	15	£121.32
3"	RFACUA0900	51	180	113	15	£180.54
4"	RFACUA1100	61	220	132	15	£265.72

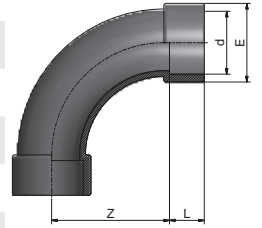

## PSPVF

### Solvent Welded Fittings Imperial Tee 90° Plain

Nominal size (d)	Code	L	Z	E	PN	Price each
⅜"	RFATIA0160	15	9	24	15	£3.05
½"	RFATIA0200	17	11	28	15	£3.59
¾"	RFATIA0250	20	14	34	15	£4.55
1"	RFATIA0320	23	17	42	15	£6.74
1¼"	RFATIA0400	27	21	51	15	£9.71
1½"	RFATIA0500	32	26	61	15	£13.92
2"	RFATIA0630	38	33	75	15	£22.18
2½"	RFATIA0750	44	39	89	15	£38.05
3"	RFATIA0900	51	47	106	15	£63.98
4"	RFATIA1100	63	57	133	15	£93.79
5"	RFATIA1400	76	71	163	15	£250.93
6"	RFATIA1600	90	81	198	15	£326.14
8"	RFATIA2250	119	114	258	9	£777.14

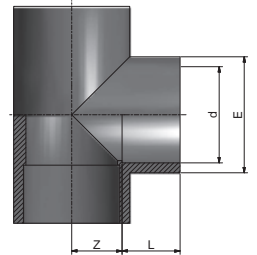

## PSPVF

### Solvent Welded Fittings Imperial Tee 45° Plain

Nominal size (d)	Code	L	Z1	Z2	E	PN	Price each
½"	RFATYA0200	16	7	29	27.5	15	£8.64
1"	RFATYA0320	22	8	44	42	15	£15.90
1½"	RFATYA0500	31	12	65	61	15	£24.57
2"	RFATYA0630	38	14	80	74.5	15	£38.02

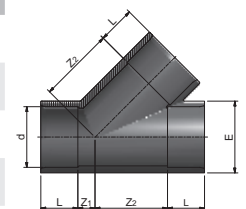

## PSPVF

### Solvent Welded Fittings Imperial Cross 90° Plain

Nominal size (d)	Code	L	Z	E	PN	Price each
½"	<b>RFACXA0200</b>	16	11	27.5	15	£14.58
1"	<b>RFACXA0320</b>	22	17	42	15	£17.81
1½"	<b>RFACXA0500</b>	31	26	61	15	£32.37
2"	<b>RFACXA0630</b>	38	33	75	15	£48.39

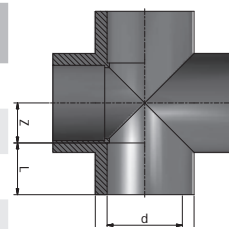

PVCu - Imperial

## PSPVF

### Solvent Welded Fittings Imperial Reducing Socket Plain

Nominal size (d)	Code	d1	L	L1	Z	E	E1	PN	Price each
1¼" x 1"	<b>RFAMRA040D</b>	1"	26	22	6	51	41	15	£6.70
1½" x 1¼"	<b>RFAMRA050E</b>	1¼"	31	26	6	61	50	15	£9.79
2" x 1½"	<b>RFAMRA063F</b>	1½"	38	31	6	75	60.5	15	£13.18
4" x 3"	<b>RFAMRA110I</b>	3"	61	51	6	129	106	15	£60.48

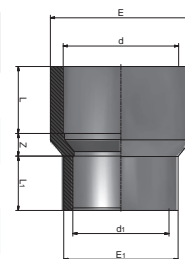

## PSPVF

### Solvent Welded Fittings Imperial Reducing Bush Plain

Nominal size (d)	Code	d1	L	Z	PN	Price each
½" x ¾"	<b>RFARCA020A</b>	¾"	15	2	15	£1.86
¾" x 1"	<b>RFARCA025B</b>	1"	17	3	15	£2.37
1" x 1½"	<b>RFARCA032B</b>	1½"	17	6	15	£3.06
1" x ¾"	<b>RFARCA032C</b>	¾"	20	3	15	£3.06
1¼" x 1"	<b>RFARCA040D</b>	1"	23	4	15	£4.08
1½" x ¾"	<b>RFARCA050C</b>	¾"	20	12	15	£4.95
1½" x 1"	<b>RFARCA050D</b>	1"	23	9	15	£4.95
1½" x 1¼"	<b>RFARCA050E</b>	1¼"	27	5	15	£4.95
2" x 1"	<b>RFARCA063D</b>	1"	23	16	15	£6.79
2" x 1¼"	<b>RFARCA063E</b>	1¼"	27	11	15	£6.79
2" x 1½"	<b>RFARCA063F</b>	1½"	32	6	15	£6.79
2½" x 1½"	<b>RFARCA075F</b>	1½"	32	13	15	£12.12
2½" x 2"	<b>RFARCA075G</b>	2"	38	6	15	£12.12
3" x 1½"	<b>RFARCA090F</b>	1½"	32	20	15	£19.41
3" x 2"	<b>RFARCA090G</b>	2"	38	14	15	£19.41
3" x 2½"	<b>RFARCA090H</b>	2½"	44	8	15	£19.41
4" x 2"	<b>RFARCA110G</b>	2"	38	23	15	£26.67
4" x 3"	<b>RFARCA110I</b>	3"	52	9	15	£26.67
5" x 4"	<b>RFARCA140L</b>	4"	63	15	15	£76.87
6" x 4"	<b>RFARCA160L</b>	4"	63	26	15	£82.64
8" x 6"	<b>RFARCA225M</b>	6"	90	33	9	£254.39

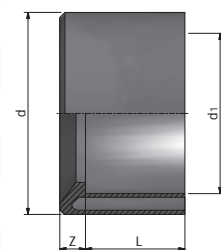

### PSPVF

#### Solvent Welded Fittings Imperial Cap Plain

Nominal size (d)	Code	L	H	E	PN	Price each
3/8"	RFACAA0160	15	26	23	15	£1.98
1/2"	RFACAA0200	17	30	27	15	£2.23
3/4"	RFACAA0250	20	34	33	15	£2.63
1"	RFACAA0320	23	38	42	15	£3.01
1 1/4"	RFACAA0400	27	43	50	15	£4.61
1 1/2"	RFACAA0500	32	48	61	15	£6.41
2"	RFACAA0630	38	56	75	15	£9.41
2 1/2"	RFACAA0750	44	67	89	15	£22.86
3"	RFACAA0900	51	78	106	15	£28.89
4"	RFACAA1100	63	81	133	15	£44.42
5"	RFACAA1400	76	114	162	15	£76.72
6"	RFACAA1600	90	127	198	15	£123.09
8"	RFACAA2250	119	165	255	9	£355.95

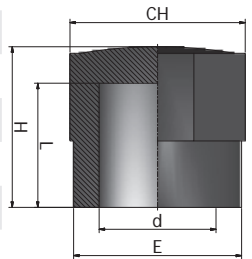
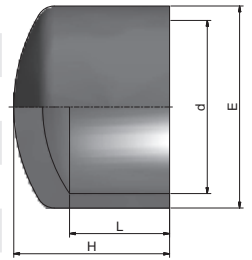

### PSPVF

#### PVC-u Solvent Cement Fittings Imperial Adaptor Socket Plain

Nominal size	d	Code	d1	L	L1	Z	E	PN	Price each
1/2" x 20	1/2"	RFBMAB0200	20	17	16	4	26	16	£3.07
3/4" x 25	3/4"	RFBMAB0250	25	20	19	4	33	16	£3.25
1" x 32	1"	RFBMAB0320	32	23	22	4	41	16	£4.02
1 1/4" x 40	1 1/4"	RFBMAB0400	40	27	26	4	51	16	£6.11
1 1/2" x 50	1 1/2"	RFBMAB0500	50	32	31	4	60	16	£8.71
2" x 63	2"	RFBMAB0630	63	38	38	3	74	16	£19.82
3" x 90	3"	RFBMAB0900	90	51	50	6	105	16	£35.57
4" x 110	4"	RFBMAB1100	110	63	61	8	128	16	£57.92
6" x 160	6"	RFBMAB1600	160	90	86	12	182	16	£143.30

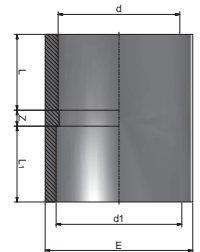

### PSPVF

#### Solvent Welded Fittings Imperial Adaptor Union Plain

Nominal size	d	Code	Rp	L1	L2	Z	H	E	F	PN	Price each
1/2" x 20	20	RFBBOB0200	1/2"	16	15	14	45	43	1"	16	£17.87
3/4" x 25	25	RFBBOB0250	3/4"	19	16.3	15.7	51	54	1 1/4"	16	£20.07
1" x 32	32	RFBBOB0320	1"	22	19.5	15.5	57	60	1 1/2"	16	£30.98
1 1/4" x 40	40	RFBBOB0400	1 1/4"	27	21.4	19.6	68	75	2"	16	£38.90
1 1/2" x 50	50	RFBBOB0500	1 1/2"	31	21.4	27.6	80	81	2 1/4"	16	£49.75
2" x 63	63	RFBBOB0630	2"	38	25.7	34.3	98	99	2 3/4"	16	£58.40
3" x 90	90	RFBBOB0900	3"	51	33.3	40.7	125	134	4"	16	£231.22
4" x 110	110	RFBBOB1100	4"	61	39.3	44.7	145	163	5"	16	£251.46

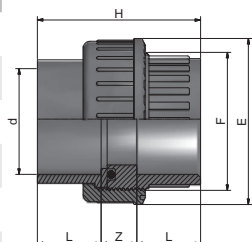



# PVC-u Flanges Imperial

**PSPVF**

**PVC-u Flanges Imperial**  
Stub Flange (Serrated Face) Plain

Nominal size (d)	Code	d1	L	S	Z	E	PN	Price each
1/2"	RFAQRA0200	27	16	3	3	34	15	£2.85
3/4"	RFAQRA0250	33	19	3	4	41	15	£3.00
1"	RFAQRA0320	41	22	7	4	50	15	£3.59
1 1/4"	RFAQRA0400	50	26	8	3	61	15	£5.78
1 1/2"	RFAQRA0500	61	32	9	4	73	15	£8.67
2"	RFAQRA0630	76	38	10	4	90	15	£13.92
2 1/2"	RFAQRA0750	90	44	10	5	106	15	£22.73
3"	RFAQRA0900	108	52	11	4	125	15	£28.03
4"	RFAQRA1100	131	62	12	5	149	15	£36.96
5"	RFAQRA1400	165	77	13	8	189	15	£76.61
6"	RFAQRA1600	188	87	13	7	214	15	£94.61
8"	RFAQRA2250	248	119	20	9	273	9	£288.93

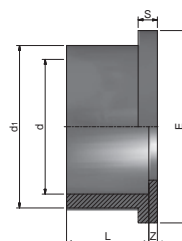

PVCu - Imperial

**PSPVF**

**PVC-u Flanges Imperial**  
Drilled to BS 10 Table D & E plain

Nominal size (d)	Code	DN	L	i	f	S	Z	E	n° x M	PN	Price each
1/2"	RFAFFA0200	15	16	65	14	11	4.5	95	4 x M12	15	£11.35
3/4"	RFAFFA0250	20	19	75	14	12	4.5	105	4 x M12	15	£11.55
1"	RFAFFA0320	25	22	85	14	14	4.5	115	4 x M12	15	£14.82
1 1/2"	RFAFFA0500	40	31	98	18	16	4.5	152	4 x M16	15	£20.59
2"	RFAFFA0630	50	38	115	18	20	4.5	165	4 x M16	15	£27.05
3"	RFAFFA0900	80	51	146	18	20	7	200	8 x M16	15	£48.77
4"	RFAFFA110E	100	61	178	18	23	8	220	8 x M16	15	£67.66

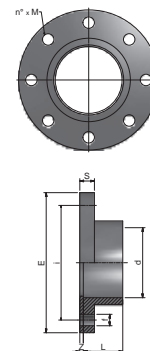

## PSPVF

**PVC-u Flanges Imperial**  
Drilled to BS 4504 NP10/16 Plain

Nominal size (d)	Code	L	i	f	S	Z	E	n° x M	PN	Price each
1/2"	<b>RFAFNA0200</b>	16	65	14	11	4.5	95	4 x M12	15	£13.59
3/4"	<b>RFAFNA0250</b>	19	75	14	12	4.5	105	4 x M12	15	£13.83
1"	<b>RFAFNA0320</b>	22	85	14	14	4.5	115	4 x M12	15	£14.82
1 1/4"	<b>RFAFNA0400</b>	26	100	18	15	4.5	142	4 x M16	15	£17.55
1 1/2"	<b>RFAFNA0500</b>	31	110	18	16	4.5	152	4 x M16	15	£20.59
2"	<b>RFAFNA0630</b>	38	125	18	20	5	165	4 x M16	15	£27.05
2 1/2"	<b>RFAFNA0750</b>	44	145	18	19	6	185	4 x M16	15	£43.31
3"	<b>RFAFNA0900</b>	51	160	18	22	7	200	8 x M16	15	£48.77
4"	<b>RFAFNA1100</b>	63	180	18	23	8	220	8 x M16	15	£67.60

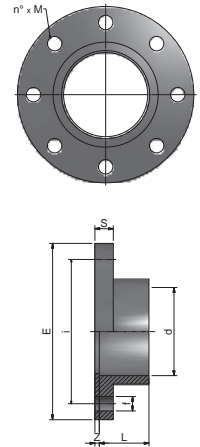

## PSPVF

**PVC-u Flanges Imperial**  
Blanking Flange Drilled to BS 10 table D/E

Nominal size (d)	Code	i	f	S	E	n° x M	PN	Price each
1/2"	<b>RFAFEA0200</b>	65	14	11	95	4 x M12	20	£75.90
3/4"	<b>RFAFEA0250</b>	75	14	12	105	4 x M12	25	£86.35
1"	<b>RFAFEA0320</b>	85	14	14	115	4 x M12	32	£93.85
1 1/4"	<b>RFAFEA0400</b>	100	18	15	141	4 x M16	40	£98.82
1 1/2"	<b>RFAFEA0500</b>	110	18	16	150	4 x M16	50	£106.83
2"	<b>RFAFEA0630</b>	125	18	18	165	4 x M16	63	£119.62
3"	<b>RFAFEA0900</b>	160	18	20	200	8 x M16	90	£211.39
4" D	<b>RFAFEA110D</b>	180	18	22	220	8 x M16	110	£271.94
4" E	<b>RFAFEA110E</b>	180	18	22	220	8 x M16	110	£271.94
6"	<b>RFAFEA1600</b>	240	22	28	285	8 x M20	160	£477.41

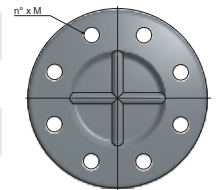
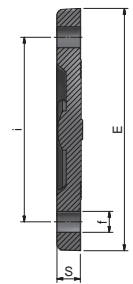

**PSPVF**

**PVC-u Flanges Imperial**  
Blanking Flange Drilled to BS4504 NP10/16

Nominal size (d)	Code	i	f	S	E	n° x M	PN	Price each
½"	<b>RFIFCI0200</b>	65	14	11	95	4 x M12	20	£37.94
¾"	<b>RFIFCI0250</b>	75	14	12	105	4 x M12	25	£43.17
1"	<b>RFIFCI0320</b>	85	14	14	115	4 x M12	32	£55.67
1¼"	<b>RFIFCI0400</b>	100	18	15	141	4 x M16	40	£58.63
1½"	<b>RFIFCI0500</b>	110	18	16	150	4 x M16	50	£63.37
2"	<b>RFIFCI0630</b>	125	18	18	165	4 x M16	63	£70.94
2½"	<b>RFIFCI0750</b>	145	18	19	185	4 x M16	75	£106.25
3"	<b>RFIFCI0900</b>	160	18	20	200	8 x M16	90	£125.39
4"	<b>RFIFCI1100</b>	180	18	22	220	8 x M16	110	£161.28
5"	<b>RFIFCI1400</b>	210	18	26	250	8 x M16	140	£252.00
6"	<b>RFIFCI1600</b>	240	22	28	285	8 x M20	160	£283.14
8"	<b>RFIFCI2250</b>	295	22	30	345	8 x M20	225	£525.00

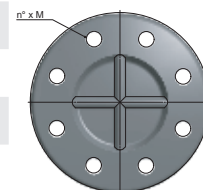
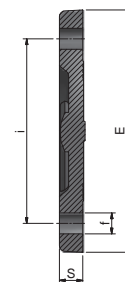

PVCu - Imperial

# PVC-u Adaptor Fittings Imperial

**PSPVF**

**PVC-u Adaptor Fittings Imperial**  
Socket Plain/BSP Female Threaded

Nominal size (d)	Rp	Code	L1	L2	CH	Z	E	PN	Price each
½"	½"	RFCMAC0200	17	15	30	4	28	15	£6.51
¾"	¾"	RFCMAC0250	20	16.3	36	6	34	15	£7.25
1"	1"	RFCMAC0320	23	19.8	46	6	42	15	£9.01
1¼"	1¼"	RFCMAC0400	27	21.4	55	7	51	15	£13.92
1½"	1½"	RFCMAC0500	32	21.4	65	7	61	15	£16.17
2"	2"	RFCMAC0630	38	28	75	6	75	15	£21.06
2½"	2½"	RFCMAC0750	44	30.2	90	8	89	15	£52.66
3"	3"	RFCMAC0900	52	33	110	7	106	15	£59.31
4"	4"	RFCMAC1100	63	39.3	130	5	134	15	£68.14

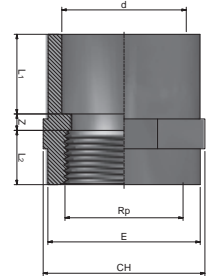

**PSPVF**

**PVC-u Adaptor Fittings Imperial**  
Socket Plain/BSP Female Threaded with Stainless Steel Reinforcing Ring

Nominal size (d)	Rp	Code	L1	L2	CH	Z	E	PN	Price each
½"	½"	RFRMAR0200	17	15	30	4	28	15	£10.00
¾"	¾"	RFRMAR0250	20	16.3	36	6	34	15	£10.91
1"	1"	RFRMAR0320	23	19.8	46	6	42	15	£12.75
1¼"	1¼"	RFRMAR0400	27	21.4	55	7	51	15	£18.51
1½"	1½"	RFRMAR0500	32	21.4	65	7	61	15	£21.20
2"	2"	RFRMAR0630	38	28	75	6	73	15	£26.67

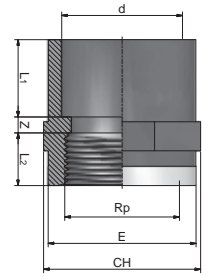

**PSPVF**

**PVC-u Adaptor Fittings Imperial**  
Spigot plain/BSP Female Threaded

Nominal size (d)	Rp	Code	L1	L2	CH	H	PN	Price each
½"	½"	RFC AFC0200	17	15	30	40	15	£5.35
¾"	¾"	RFC AFC0250	20	16.3	36	45	15	£6.19
1"	1"	RFC AFC0320	23	19.1	46	51	15	£7.56
1¼"	1¼"	RFC AFC0400	27	21.4	55	58	15	£9.87
1½"	1½"	RFC AFC0500	32	21.4	65	64	15	£12.75
2"	2"	RFC AFC0630	39	26	75	75	15	£18.29
2½"	2½"	RFC AFC0750	44	30.2	90	88	15	£33.08

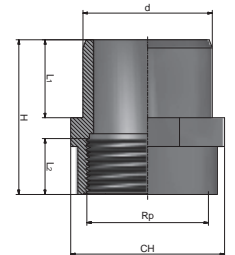

PVC-u - Imperial



# PVC-u Adaptor Fittings Imperial

## PSPVF

### PVC-u Adaptor Fittings Imperial

Spigot plain/BSP Female Threaded with Stainless Steel Reinforcing Ring

Nominal size (d)	Rp	Code	L1	L2	CH	H	E	PN	Price each
½"	½"	RFRAFR0200	17	15	30	40	28	15	£7.67
¾"	¾"	RFRAFR0250	20	16	36	45	34	15	£8.86
1"	1"	RFRAFR0320	23	19	46	51	42	15	£11.24
1¼"	1¼"	RFRAFR0400	27	21	55	58	51	15	£14.34
1½"	1½"	RFRAFR0500	32	21	65	64	61	15	£17.67
2"	2"	RFRAFR0630	39	26	80	75	71	15	£23.68

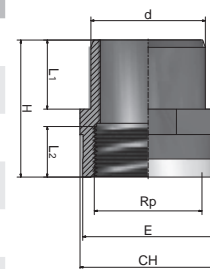

PVCu - Imperial

## PSPVF

### PVC-u Adaptor Fittings Imperial

Union Plain/BSP Female Threaded

Nominal size (d)	Rp	Code	L1	L2	Z	H	E	F	PN	Price each
½"	½"	RFCBOC0200	16	15	14	45	43	1"	15	£17.45
¾"	¾"	RFCBOC0250	19	16.3	15.7	51	54	1¼"	15	£19.27
1"	1"	RFCBOC0320	22	19.5	15.5	57	60	1½"	15	£23.98
1¼"	1¼"	RFCBOC0400	27	21.4	19.6	68	75	2"	15	£38.40
1½"	1½"	RFCBOC0500	31	21.4	27.6	80	81	2¼"	15	£38.85
2"	2"	RFCBOC0630	38	25.7	34.3	98	99	2¾"	15	£53.43
2½"	2½"	RFCBOC0750	44	30.2	35.8	110	120	3½"	15	£95.87
3"	3"	RFCBOC0900	51	33.3	40.7	125	134	4"	15	£156.18
4"	4"	RFCBOC1100	61	39.3	44.7	145	163	5"	15	£211.93

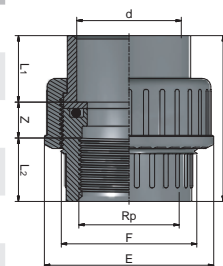

## PSPVV

### PVC-u Adaptor Fittings Imperial

Composite Union Plain/BSP Female Brass Threaded with Plastic Nut

Nominal size (d)	Rp	Code	L1	L2	CH	H	E	F	PN	Price each
½"	½"	RFCPFC0200	16	14	30	47	43	1"	15	£43.86
¾"	¾"	RFCPFC0250	19	16	36	52	54	1¼"	15	£58.93
1"	1"	RFCPFC0320	22	19	46	58	60	1½"	15	£75.94
1¼"	1¼"	RFCPFC0400	27	23	55	65	75	2"	15	£119.61
1½"	1½"	RFCPFC0500	31	23	65	71	81	2¼"	15	£141.70
2"	2"	RFCPFC0630	38	23	80	85	99	2¾"	15	£222.26

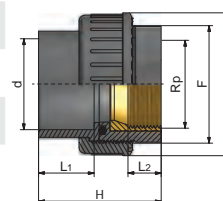
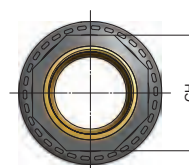

## PSPVF

### PVC-u Adaptor Fittings Imperial

Composite Union Plain/BSP Female Brass Threaded

Nominal size (d)	Rp	Code	L1	L2	Z1	Z2	CH1	CH2	H	PN	Price each
½"	½"	RFCBFC0200	16	12	3	9	26	44	40	15	£45.19
¾"	¾"	RFCBFC0250	19	13	3	9	32	46	44	15	£60.71
1"	1"	RFCBFC0320	22	16	3	10	38	55	51	15	£78.23
1¼"	1¼"	RFCBFC0400	27	18	3	11	47	65	59	15	£123.21
1½"	1½"	RFCBFC0500	31	18	4	11	54	72	64	15	£145.96
2"	2"	RFCBFC0630	38	22	4	12	66	88	76	15	£228.95
2½"	2½"	RFCBFC0750	44	24	4	12	82	108	84	15	£450.81
3"	3"	RFCBFC0900	51	31	5	13	95	121	100	15	£500.24

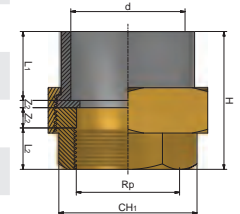
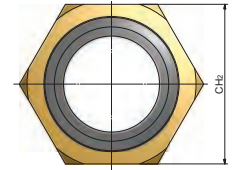

## PSPVV

### PVC-u Adaptor Fittings Imperial

Composite Union Plain/BSP Male Brass Threaded with Plastic Nut

Nominal size (d)	G	Code	L1	L2	H	E	F	CH	PN	Price each
½"	½"	RFCPMC0200	17	13	61	43	1"	30	16	£47.51
¾"	¾"	RFCPMC0250	19	14	68	54	1¼"	36	16	£60.81
1"	1"	RFCPMC0320	23	18	77	60	1½"	46	16	£80.13
1¼"	1¼"	RFCPMC0400	27	21	87	75	2"	55	16	£125.04
1½"	1½"	RFCPMC0500	37	21	95	81	2¼"	65	16	£151.84
2"	2"	RFCPMC0630	41	21	108	99	2¾"	80	16	£232.76

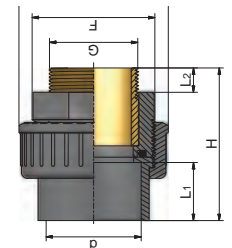
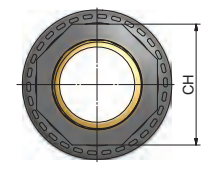

## PSPVF

### PVC-u Adaptor Fittings Imperial

Composite Union Plain/BSP Male Taper Brass Threaded

Nominal size (d)	G	Code	L1	L2	Z1	Z2	CH1	CH2	H	PN	Price each
½"	½"	RFCBMC0200	16	13.2	3	19.8	25	44	52	15	£48.95
¾"	¾"	RFCBMC0250	19	14.5	3	23.5	31	46	60	15	£62.66
1"	1"	RFCBMC0320	22	16.8	3	24.2	38	55	66	15	£82.07
1¼"	1¼"	RFCBMC0400	27	21	3	28	47	65	79	15	£128.81
1½"	1½"	RFCBMC0500	31	21	4	29	53	72	85	15	£156.41
2"	2"	RFCBMC0630	38	23.4	4	31.6	66	88	97	15	£239.76
2½"	2½"	RFCBMC0750	44	26.7	4	39.3	81	108	114	15	£458.82
3"	3"	RFCBMC0900	51	27.2	5	42.8	95	121	126	15	£597.73

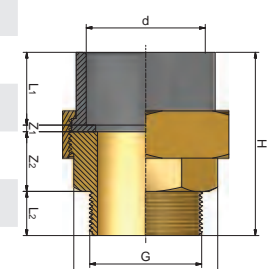
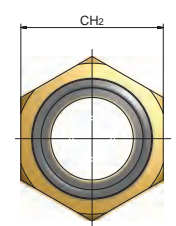

PVCu - Imperial

## PSPVF

### PVC-u Adaptor Fittings Imperial Elbow 90° Plain/BSP Female Threaded

Nominal size (d)	Rp	Code	L1	L2	Z1	Z2	E	PN	Price each
½"	½"	RFCGOC0200	17	15	11	13	28	15	£7.63
¾"	¾"	RFCGOC0250	20	16.3	14	17	34	15	£8.78
1"	1"	RFCGOC0320	23	19.1	17	21	42	15	£10.85
1¼"	1¼"	RFCGOC0400	27	21.4	21	27	51	15	£22.63
1½"	1½"	RFCGOC0500	32	21.4	26	37	61	15	£25.10
2"	2"	RFCGOC0630	39	26	33	46	75	15	£35.36
2½"	2½"	RFCGOC0750	44	30.2	39	53	89	15	£59.47
3"	3"	RFCGOC0900	52	33.3	47	65	106	15	£79.88

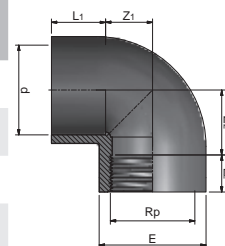

PVCu - Imperial

## PSPVF

### PVC-u Adaptor Fittings Imperial Elbow 90° Plain/BSP Female Threaded with Stainless Steel Reinforcing Ring

Nominal size (d)	Rp	Code	L1	L2	Z1	Z2	E	PN	Price each
½"	½"	RFRGOR0200	17	15	11	13	28	15	£11.09
¾"	¾"	RFRGOR0250	20	16.3	14	17	34	15	£12.49
1"	1"	RFRGOR0320	23	19.1	17	21	42	15	£14.68
1¼"	1¼"	RFRGOR0400	27	21.4	21	27	51	15	£20.68
1½"	1½"	RFRGOR0500	32	21.4	26	37	61	15	£30.20
2"	2"	RFRGOR0630	39	26	33	46	75	15	£41.14

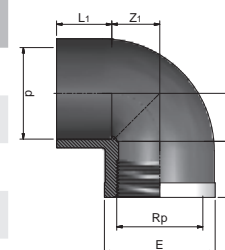

## PSPVF

### PVC-u Adaptor Fittings Imperial Tee 90° Plain/BSP Female Threaded

Nominal size (d)	Rp	Code	L1	L2	Z1	Z2	E	PN	Price each
½"	½"	RFCTIC0200	17	15	11	13	28	15	£9.82
¾"	¾"	RFCTIC0250	19	16.3	14	17	34	15	£10.79
1"	1"	RFCTIC0320	23	19.1	17	21	42	15	£12.03
1¼"	1¼"	RFCTIC0400	27	21.4	21	27	51	15	£22.63
1½"	1½"	RFCTIC0500	32	21.4	26	37	61	15	£23.83
2"	2"	RFCTIC0630	39	26	33	46	75	15	£37.16
2½"	2½"	RFCTIC0750	44	30.2	39	53	89	15	£59.11
3"	3"	RFCTIC0900	52	33.3	47	65	106	15	£69.47

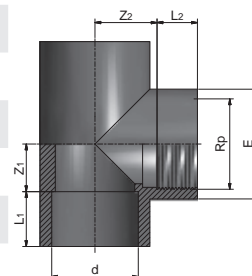

## PSPVF

### PVC-u Adaptor Fittings Imperial

Tee 90° Plain/BSP Female Threaded Branch with Stainless Steel Reinforcing Ring

Nominal size (d)	Rp	Code	L1	L2	Z1	Z2	E	PN	Price each
½"	½"	RFRTIR0200	17	15	11	13	28	15	£13.30
¾"	¾"	RFRTIR0250	19	16.3	14	17	34	15	£14.46
1"	1"	RFRTIR0320	23	19.1	17	21	42	15	£15.80
1¼"	1¼"	RFRTIR0400	27	21.4	21	27	51	15	£27.31
1½"	1½"	RFRTIR0500	32	21.4	26	37	61	15	£31.45
2"	2"	RFRTIR0630	39	26	33	46	75	15	£42.94

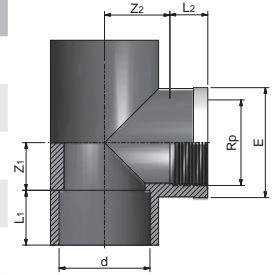

## PSPVF

### PVC-u Adaptor Fittings Imperial

Reducing Bush Plain/BSP Female Threaded

Nominal size (d)	Rp	Code	L	Z	H	PN	Price each
½"	⅜"	RFCRCC020A	11.4	5.6	17	15	£4.48
¾"	½"	RFCRCC025B	15	4	19	15	£5.35
1"	¾"	RFCRCC032C	16.3	6.7	23	15	£7.32

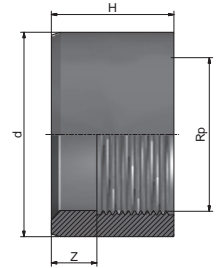

## PSPVF

### PVC-u Adaptor Fittings Imperial

Socket Plain/BSP Male Threaded

Nominal size (d)	d1	Code	G	L	L1	L2	CH	H	PN	Price each
½"	¾"	RFCAMC0200	½"	17	20	15	30	46	15	£4.01
¾"	1"	RFCAMC0250	¾"	20	23	16.3	36	50	15	£4.61
1"	1¼"	RFCAMC0320	1"	23	27	19.1	46	57	15	£7.16
1¼"	1½"	RFCAMC0400	1¼"	27	32	21.4	55	67	15	£9.81
1½"	2"	RFCAMC0500	1½"	32	39	21.4	65	74	15	£12.64
2"	2½"	RFCAMC0630	2"	39	44	25.7	80	84	15	£17.04
2½"	3"	RFCAMC0750	2½"	44	52	30.2	95	99	15	£42.55
3"	4"	RFCAMC0900	3"	52	63	33.3	115	113	15	£50.36
4"	5"	RFCAMC1100	4"	63	66	39.3	130	120	15	£67.86

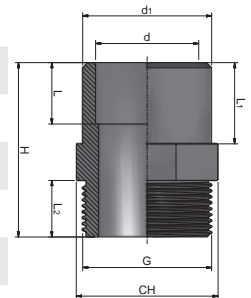

## PSPVF

### PVC-u Adaptor Fittings Imperial

Barrel Nipple Plain/BSP Male Taper Threaded . (½" to 4" 9 bar at 20°C)

Nominal size (d)	Code	L1	L2	Price each
⅜"	RFCBNC0160	42	13	£4.48
½"	RFCBNC0200	50	16	£4.84
¾"	RFCBNC0250	56	17	£5.81
1"	RFCBNC0320	63	20	£7.67
1¼"	RFCBNC0400	75	24	£10.48
1½"	RFCBNC0500	88	30	£10.95
2"	RFCBNC0630	88	32	£14.68
2½"	RFCBNC0750	106	35	£34.34
3"	RFCBNC0900	128	39	£38.40
4"	RFCBNC1100	153	43	£57.57

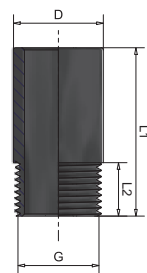

PVCu - Imperial

## PSPVF

### PVC-u Adaptor Fittings Imperial

Tank Connector Plain/BSP Male Threaded EPDM Gasket. (½" to 4" 9 bar at 20°C)

Nominal size (d)	Code	L1	L2	O	Price each
½"	RFCTCC0200	77	42	38	£15.33
¾"	RFCTCC0250	77	42	42	£17.52
1"	RFCTCC0320	103	55	55	£37.25
1¼"	RFCTCC0400	121	70	65	£69.53
1½"	RFCTCC0500	128	73	72	£80.61
2"	RFCTCC0630	154	82	93	£88.08
2½"	RFCTCC0750	164	94	106	£130.42
3"	RFCTCC0900	202	110	125	£149.71
4"	RFCTCC1100	230	140	154	£160.66

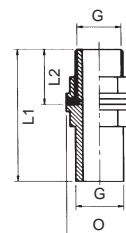

# PVC-u Threaded Fittings Imperial

**PSPVF**
**PVC-u Threaded Fittings Imperial**  
 Socket BSP Female Threaded

Nominal size (Rp)	Code	L	CH	Z	E	PN	Price each
3/8"	RFFMAF0160	11	24	5	24	16	£10.94
1/2"	RFFMAF0200	15	30	6	28	16	£11.37
3/4"	RFFMAF0250	16.3	36	6.2	34	16	£12.82
1"	RFFMAF0320	19.1	46	6.6	42	16	£15.34
1 1/4"	RFFMAF0400	21.4	55	7	51	16	£21.08
1 1/2"	RFFMAF0500	21.41	65	8	62	16	£24.34
2"	RFFMAF0630	26	75	8	77	16	£29.17
2 1/2"	RFFMAF0750	30.2	95	9	89	16	£64.29
3"	RFFMAF0900	33.3	105	10	106	16	£82.23
4"	RFFMAF1100	39.3	130	11	129	16	£145.05

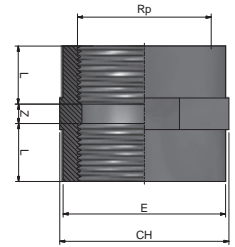
**PSPVF**
**PVC-u Threaded Fittings Imperial**  
 Union BSP Female Threaded

Nominal size (Rp)	Code	L min	F	Z max	H	E	PN	Price each
3/8"	RFFBOF0160	11.4	3/4"	19.2	42	34	16	£18.98
1/2"	RFFBOF0200	15	1"	15	45	43	16	£25.06
3/4"	RFFBOF0250	16.3	1 1/4"	18.4	51	54	16	£27.14
1"	RFFBOF0320	19.5	1 1/2"	18	57	60	16	£38.68
1 1/4"	RFFBOF0400	21.4	2"	25.2	68	75	16	£47.68
1 1/2"	RFFBOF0500	21.4	2 1/4"	37.2	80	81	16	£66.93
2"	RFFBOF0630	25.7	2 3/4"	46.6	98	99	16	£94.28
2 1/2"	RFFBOF0750	30.2	3 1/2"	49.6	110	120	16	£149.20
3"	RFFBOF0900	33.3	4"	58.4	125	134	16	£216.47
4"	RFFBOF1100	39.3	5"	66.4	145	163	16	£292.73

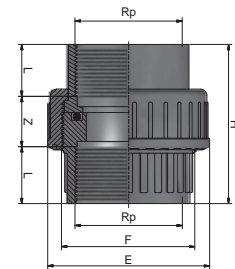



## PSPVF

### PVC-u Threaded Fittings Imperial Elbow 90° BSP Female Threaded

Nominal size (Rp)	Code	L	Z	E	PN	Price each
3/8"	RFFGOF0160	11.4	12	24	16	£10.62
1/2"	RFFGOF0200	15	13	28	16	£10.94
3/4"	RFFGOF0250	16.3	17	34	16	£11.37
1"	RFFGOF0320	19.1	21	42	16	£14.09
1 1/4"	RFFGOF0400	21.4	27	51	16	£24.95
1 1/2"	RFFGOF0500	21.4	37	62	16	£29.20
2"	RFFGOF0630	26	46	77	16	£43.43
2 1/2"	RFFGOF0750	30.2	53	89	16	£74.53
3"	RFFGOF0900	33.3	65	106	16	£113.06
4"	RFFGOF1100	39.3	79	129	16	£161.64

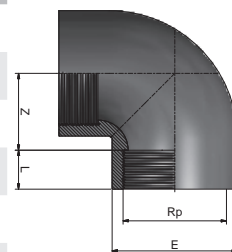

PVCu - Threaded

## PSPVF

### PVC-u Threaded Fittings Imperial Elbow 45° BSP Female Threaded

Nominal size (Rp)	Code	L	Z	E	PN	Price each
1/2"	RFFGYF0200	15	6	28	16	£10.23
3/4"	RFFGYF0250	16.3	9	34	16	£11.03
1"	RFFGYF0320	19.1	11	42	16	£14.82
1 1/4"	RFFGYF0400	21.4	15	51	16	£22.49
1 1/2"	RFFGYF0500	21.4	22	62	16	£29.98
2"	RFFGYF0630	26	26	77	16	£44.27
2 1/2"	RFFGYF0750	30.2	31	89	16	£73.27
3"	RFFGYF0900	33.3	38	106	16	£108.14
4"	RFFGYF1100	39.3	46	129	16	£119.48

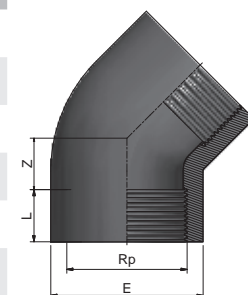

## PSPVF

### PVC-u Threaded Fittings Imperial Tee 90° BSP Female Threaded

Nominal size (Rp)	Code	L	Z	E	PN	Price each
3/8"	RFFTIF0160	11.4	12	24	16	£7.99
1/2"	RFFTIF0200	15	13	28	16	£9.42
3/4"	RFFTIF0250	16.3	17	34	16	£12.12
1"	RFFTIF0320	19.1	21	42	16	£16.27
1 1/4"	RFFTIF0400	21.4	27	51	16	£29.04
1 1/2"	RFFTIF0500	21.4	37	62	16	£37.63
2"	RFFTIF0630	26	46	77	16	£63.23
2 1/2"	RFFTIF0750	30.2	53	89	16	£89.98
3"	RFFTIF0900	33.3	65	106	16	£129.13
4"	RFFTIF1100	39.3	79	129	16	£215.07

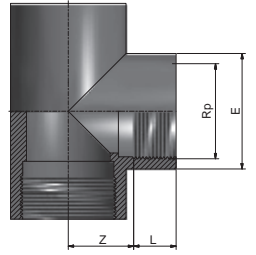

## PSPVF

### PVC-u Threaded Fittings Imperial Reducing piece BSP Female Threaded/BSP Female Threaded

Nominal size	Rp1	Code	Rp2	L1 min	L2 min	Z max	CH	E1	E2	PN	Price each
1/2" x 3/8"	1/2"	RFFMRF020A	3/8"	13.2	10.1	8.7	30	28	23	16	£9.24
3/4" x 1/2"	3/4"	RFFMRF025B	1/2"	14.5	13.2	10.3	36	34	27	16	£10.54
1" x 3/4"	1"	RFFMRF032C	3/4"	16.8	14.5	10.7	46	42	33	16	£12.49
1 1/4" x 1"	1 1/4"	RFFMRF040D	1"	19.1	16.8	12.1	55	51	41	16	£16.92
1 1/2" x 1 1/4"	1 1/2"	RFFMRF050E	1 1/4"	19.1	19.1	11.8	65	58	50	16	£19.59
2" x 1 1/2"	2"	RFFMRF063F	1 1/2"	23.4	19.1	12.5	75	72	61	16	£24.07
2 1/2" x 2"	2 1/2"	RFFMRF075G	2"	26.7	23.4	13.9	95	89	75	16	£51.78
3" x 2 1/2"	3"	RFFMRF090H	2 1/2"	29.8	26.7	15.5	105	103	88	16	£66.31
4" x 3"	4"	RFFMRF110I	3"	35.8	29.8	16.4	130	130	106	16	£115.20

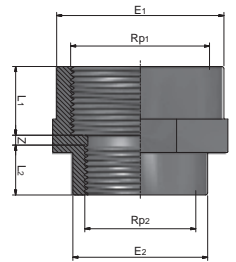

## PSPVF

### PVC-u Threaded Fittings Imperial Reducing Piece BSP Female Threaded/BSP Male Threaded

Nominal size	Rp	Code	G	L1	L2	E	CH	H	PN	Price each
1/2" x 3/8"	1/2"	RFFMGF020A	3/8"	11.4	15	28	30	36	16	£9.24
3/4" x 1/2"	3/4"	RFFMGF025B	1/2"	15	16.3	34	36	41.3	16	£10.54
1" x 3/4"	1"	RFFMGF032C	3/4"	16.3	19.1	42	46	46.1	16	£16.92
1 1/4" x 1"	1 1/4"	RFFMGF040D	1"	19.1	21.4	51	55	50.7	16	£20.33
1 1/2" x 1 1/4"	1 1/2"	RFFMGF050E	1 1/4"	21.4	21.4	58	60	58.4	16	£20.77
2" x 1 1/2"	2"	RFFMGF063F	1 1/2"	21.4	26	72	75	70	16	£24.07
2 1/2" x 2"	2 1/2"	RFFMGF075G	2"	26	30.2	89	90	73.2	16	£51.78
3" x 2 1/2"	3"	RFFMGF090H	2 1/2"	30.2	33.3	103	105	77.3	16	£66.31
4" x 3"	4"	RFFMGF110I	3"	33.3	39.3	130	130	88.3	16	£115.20

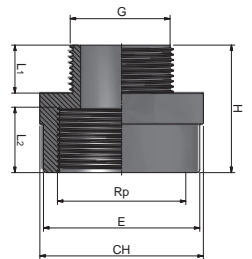

# PVC-u Threaded Fittings Imperial

**PSPVF**

**PVC-u Threaded Fittings Imperial**  
Reducing Piece BSP Male Threaded/BSP Female Threaded

Nominal size	Rp	Code	G	L1	L2	CH	H	E	PN	Price each
1/2" x 3/8"	3/8"	RFFRIF020A	1/2"	15	11.4	24	36	23	16	£5.33
3/4" x 3/8"	3/8"	RFFRIF025A	3/4"	16.3	11.4	30	37	23	16	£7.99
3/4" x 1/2"	1/2"	RFFRIF025B	3/4"	16.3	15	30	41	28	16	£7.99
1" x 3/8"	3/8"	RFFRIF032A	1"	19.1	11.4	36	40	23	16	£10.72
1" x 1/2"	1/2"	RFFRIF032B	1"	19.1	15	36	43	28	16	£10.72
1" x 3/4"	3/4"	RFFRIF032C	1"	19.1	16.3	36	45	34	16	£10.72
1 1/4" x 1/2"	1/2"	RFFRIF040B	1 1/4"	21.4	15	46	46	28	16	£12.92
1 1/4" x 3/4"	3/4"	RFFRIF040C	1 1/4"	21.4	16.3	46	50	34	16	£12.92
1 1/4" x 1"	1"	RFFRIF040D	1 1/4"	21.4	19.1	46	51	42	16	£12.92
1 1/2" x 3/4"	3/4"	RFFRIF050C	1 1/2"	21.4	16.3	50	50	34	16	£15.61
1 1/2" x 1"	1"	RFFRIF050D	1 1/2"	21.4	19.1	50	53	42	16	£15.61
1 1/2" x 1 1/4"	1 1/4"	RFFRIF050E	1 1/2"	21.4	21.4	55	55	51	16	£15.61
2" x 1"	1"	RFFRIF063D	2"	26	19.1	65	51	42	16	£25.06
2" x 1 1/4"	1 1/4"	RFFRIF063E	2"	26	21.4	65	58	51	16	£25.06
2" x 1 1/2"	1 1/2"	RFFRIF063F	2"	26	21.4	65	57	58	16	£25.06
2 1/2" x 2"	2"	RFFRIF075E	2 1/2"	30.2	21.4	80	64	71	16	£33.54
2 1/2" x 1 1/2"	1 1/2"	RFFRIF075F	2 1/2"	30.2	21.4	80	64	58	16	£33.54
2 1/4" x 2"	2"	RFFRIF075G	2 1/4"	30.2	26	80	72	71	16	£33.54
3" x 1 1/2"	1 1/2"	RFFRIF090F	3"	33.3	21.4	95	68	58	16	£41.69
3" x 2"	2"	RFFRIF090G	3"	33.3	26	95	74	71	16	£41.69
3" x 2 1/2"	2 1/2"	RFFRIF090H	3"	33.3	30.2	95	78	88	16	£41.69
4" x 2"	2"	RFFRIF110G	4"	39.3	26	120	79	71	16	£67.21
4" x 2 1/2"	2 1/2"	RFFRIF110H	4"	39.3	30.2	120	82	88	16	£67.21
4" x 3"	3"	RFFRIF110I	4"	39.3	33	120	87	102	16	£67.21

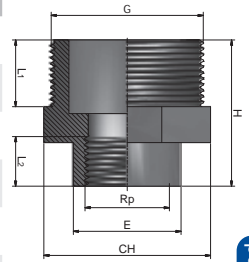

PVCu - Threaded

**PSPVF**

**PVC-u Threaded Fittings Imperial**  
Reducing Nipple BSP Male Threaded/BSP Male Threaded

Nominal size	G1	Code	G2	L1	L2	CH	H	PN	Price each
1/2" x 3/8"	1/2"	RFFNRF020A	3/8"	15	11.4	24	38	16	£5.33
3/4" x 1/2"	3/4"	RFFNRF025B	1/2"	16.3	15	30	43	16	£7.99
1" x 3/4"	1"	RFFNRF032C	3/4"	19.1	16.3	36	47	16	£10.72
1 1/4" x 1"	1 1/4"	RFFNRF040D	1"	21.4	19.1	46	56	16	£12.77
1 1/2" x 1 1/4"	1 1/2"	RFFNRF050E	1 1/4"	21.4	21.4	50	58	16	£15.90
2" x 1 1/2"	2"	RFFNRF063F	1 1/2"	26	21.4	65	62	16	£25.06
2 1/2" x 2"	2 1/2"	RFFNRF075G	2"	30.2	26	80	73	16	£33.54
3" x 2 1/2"	3"	RFFNRF090H	2 1/2"	33.3	30.2	95	82	16	£41.69
4" x 3"	4"	RFFNRF110I	3"	39.3	33.3	120	90	16	£67.21

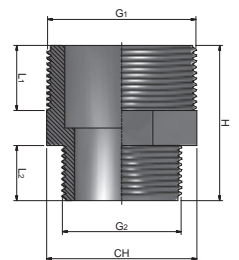

## PSPVF

**PVC-u Threaded Fittings Imperial**  
Reducing Bush BSP Male Threaded/BSP Female Threaded

Nominal size	Rp	Code	G	L1	L2	CH	H	PN	Price each
¾" x ½"	½"	RFFRCF025B	¾"	16.4	15	30	28.5	16	£7.14
1" x ¾"	¾"	RFFRCF032C	1"	19.2	16.3	36	31.2	16	£9.57
1¼" x 1"	1"	RFFRCF040D	1¼"	21.5	19	46	33.5	16	£21.22
1½" x 1¼"	1¼"	RFFRCF050E	1½"	22	21.4	50	36	16	£22.81
2" x 1½"	1½"	RFFRCF063F	2"	26	21.4	65	40	16	£29.76
2½" x 2"	2"	RFFRCF075G	2½"	31	26	80	49	16	£32.89
3" x 2½"	2½"	RFFRCF090H	3"	33.5	30.2	95	51.5	16	£40.36
4" x 3"	3"	RFFRCF110I	4"	39.3	33.3	120	57.3	16	£65.88

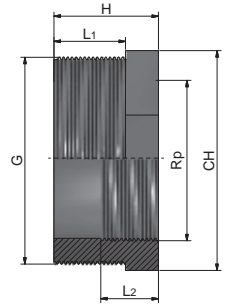

## PSPVF

**PVC-u Threaded Fittings Imperial**  
Cap BSP Female Threaded

Nominal Size (Rp)	Code	L	CH	H	E	PN	Price each
¾"	RFFCAF0160	11.4	24	22	23	16	£8.71
½"	RFFCAF0200	15	30	21	28	16	£11.37
¾"	RFFCAF0250	16.3	36	23	34	16	£12.92
1"	RFFCAF0320	19.1	46	26	42	16	£13.78
1¼"	RFFCAF0400	21.4	55	29	51	16	£14.20
1½"	RFFCAF0500	21.4	65	32	61	16	£18.96
2"	RFFCAF0630	26	75	37	75	16	£23.69
2½"	RFFCAF0750	30.2	95	50	89	16	£60.98
3"	RFFCAF0900	33.3	105	53	103	16	£71.06
4"	RFFCAF1100	39.4	130	59	130	16	£80.96

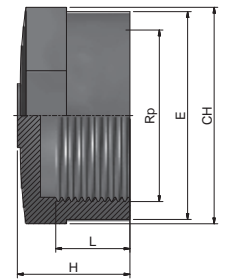

## PSPVF

**PVC-u Threaded Fittings Imperial**  
Plug BSP Male Threaded

Nominal Size (G)	Code	L	CH	H	PN	Price each
¾"	RFFTAF0160	11.4	19	23	16	£5.33
½"	RFFTAF0200	15	24	29	16	£6.73
¾"	RFFTAF0250	16.3	30	30	16	£7.80
1"	RFFTAF0320	19.1	36	33	16	£9.57
1¼"	RFFTAF0400	21.4	46	39	16	£12.92
1½"	RFFTAF0500	21.4	50	39	16	£16.27
2"	RFFTAF0630	26	65	43	16	£17.55
2½"	RFFTAF0750	30.2	80	51	16	£37.94
3"	RFFTAF0900	33.3	95	56	16	£53.84
4"	RFFTAF1100	39.3	120	63	16	£98.10

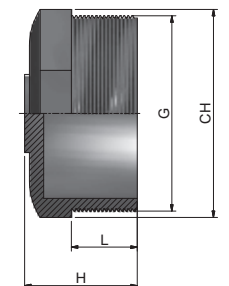

## PSPVF

### PVC-u Threaded Fittings Imperial

Full Face Flange Drilled to BS 4504 NP10/16 BSP Female Threaded

Nominal size (d)	Code	L	Z	E	f	I	S	HOLES	Price each
½"	RFFFFFF0200	15	5	95	14	65	8	4	£19.76
¾"	RFFFFFF0250	18	5	105	14	75	9	4	£20.55
1"	RFFFFFF0320	19	5	115	14	85	16	4	£23.26
1¼"	RFFFFFF0400	21	5	142	18	100	17	4	£26.36
1½"	RFFFFFF0500	21	5	152	18	110	17	4	£30.78
2"	RFFFFFF0630	26	5	165	18	125	20	4	£40.13
2½"	RFFFFFF0750	30	6	185	18	145	22	4	£68.05
3"	RFFFFFF0900	33	7	200	18	160	22	8	£75.79
4"	RFFFFFF1100	40	8	220	18	180	23	8	£101.08

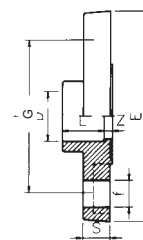

## PSPVF

### PVC-u Threaded Fittings Imperial

Barrel Nipple BSP Male Taper Threaded

Nominal size (d)	G	Code	L	H	Price each
⅜"	BSPT	RFFBAF0160	14	44	£6.40
½"	BSPT	RFFBAF0200	16	50	£6.73
¾"	BSPT	RFFBAF0250	19	56	£7.50
1"	BSPT	RFFBAF0320	21	62	£10.08
1¼"	BSPT	RFFBAF0400	24	75	£13.58
1½"	BSPT	RFFBAF0500	32	87	£14.17
2"	BSPT	RFFBAF0630	29	87	£18.96
2½"	BSPT	RFFBAF0750	30	105	£42.55
3"	BSPT	RFFBAF0900	37	128	£48.77
4"	BSPT	RFFBAF1100	42	156	£65.97

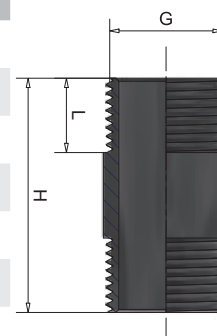

### PSPVF

#### PVC-u Threaded Fittings Imperial Hexagon Nipple BSP Male Threaded/BSP Male Threaded

Nominal size (G)	Code	L min	CH	H	PN	Price each
3/8"	RFFNIF0160	11.4	19	35	16	£5.33
1/2"	RFFNIF0200	15	24	42	16	£5.58
3/4"	RFFNIF0250	16.3	30	45	16	£7.04
1"	RFFNIF0320	19.1	36	50	16	£9.57
1 1/4"	RFFNIF0400	21.4	46	58	16	£13.05
1 1/2"	RFFNIF0500	21.4	50	58	16	£14.17
2"	RFFNIF0630	25.7	65	67	16	£18.03
2 1/2"	RFFNIF0750	30.2	80	80	16	£32.22
3"	RFFNIF0900	33.3	95	85	16	£46.21
4"	RFFNIF1100	39.3	120	96	16	£65.62

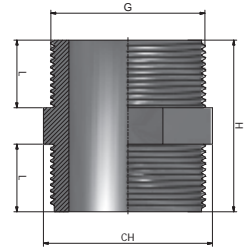

### PSPVF

#### PVC-u Threaded Fittings Imperial Hose Adaptor BSP Male Threaded/Spigot Serrated

Nominal size (G)	Code	d1	d2	L	CH	H	PN	Price each
3/8"	RFFPGF016A	16	18	12	19	64	16	£6.14
1/2"	RFFPGF020B	20	22	15	24	70	16	£6.41
3/4"	RFFPGF025C	25	27	17	30	76	16	£8.48
1"	RFFPGF032D	32	34	20	36	80	16	£10.09
1 1/4"	RFFPGF040E	40	42	22	46	92	16	£14.77
1 1/2"	RFFPGF050F	50	52	23	50	99	16	£17.61
2"	RFFPGF063G	60	63	26	65	118	16	£27.17

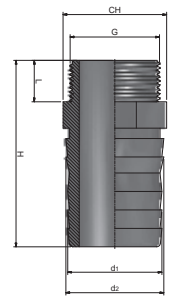

### PSPVF

#### PVC-u Threaded Fittings Imperial Backnut BSP Female Threaded

Nominal size (Rp)	Code	CH	H	E	PN	Price each
1/2"	RFFNUF0200	38	13	28	16	£4.29
3/4"	RFFNUF0250	43	14	33	16	£4.58
1"	RFFNUF0320	56	16	46	16	£8.08
1 1/4"	RFFNUF0400	65	18	50	16	£17.95
1 1/2"	RFFNUF0500	72	19	60	16	£19.46
2"	RFFNUF0630	94	21	80	16	£21.86
2 1/2"	RFFNUF0750	105	23	95	16	£28.01
3"	RFFNUF0900	125	27	110	16	£31.45
4"	RFFNUF1100	154	31	140	16	£39.59

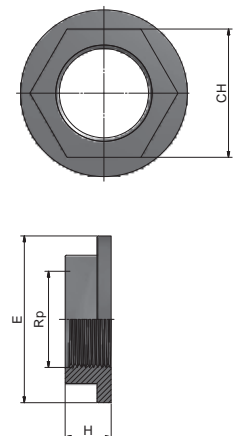



# PVC-u Solvent Cement Fittings Metric

**PSPVF**

**PVC-u Solvent Cement Fittings Metric**  
Socket Plain

Nominal size (d)	Code	L	Z	E	PN	Price each
16	RFIMAI0160	14	3	23	16	£1.98
20	RFIMAI0200	16	4	26	16	£2.09
25	RFIMAI0250	19	4	33	16	£2.37
32	RFIMAI0320	22	4	41	16	£2.63
40	RFIMAI0400	26	5	51	16	£4.16
50	RFIMAI0500	31	4	60	16	£5.18
63	RFIMAI0630	38	4	74	16	£7.46
75	RFIMAI0750	43	6	88	16	£19.08
90	RFIMAI0900	50	7	105	16	£29.27
110	RFIMAI1100	61	5	128	16	£41.91
125	RFIMAI1250	69	7	145	16	£68.79
140	RFIMAI1400	76	11	161	16	£99.32
160	RFIMAI1600	86	8	182	16	£106.65
200	RFIMAI2000	106	14	230	10	£255.10
225	RFIMAI2250	118	14	247	10	£304.77
250	RFIMAI2500	131	10	286	10	£523.39
280	RFIMAI2800	146	10	320	10	£683.24
315	RFIMAI3150	164	12	355	10	£1,028.17

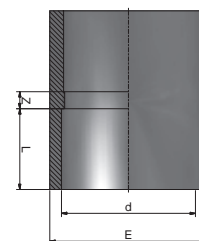

PVCu - Metric

**PSPVF**

**PVC-u Solvent Cement Fittings Metric**  
Union Plain EPDM Seals

Nominal size (d)	Code	L	F	Z	H	E	PN	Price each
16	RFIBOI0160	14	3/4"	14	42	34	16	£9.11
20	RFIBOI0200	16	1"	13	45	43	16	£10.91
25	RFIBOI0250	19	1 1/4"	13	51	54	16	£12.44
32	RFIBOI0320	22	1 1/2"	13	57	60	16	£16.09
40	RFIBOI0400	27	2"	14	68	75	16	£20.11
50	RFIBOI0500	31	2 1/4"	18	80	81	16	£27.45
63	RFIBOI0630	38	2 3/4"	22	98	99	16	£43.14
75	RFIBOI0750	44	3 1/2"	22	110	120	16	£120.35
90	RFIBOI0900	51	4"	23	125	134	16	£150.18
110	RFIBOI1100	61	5"	23	145	163	16	£178.98

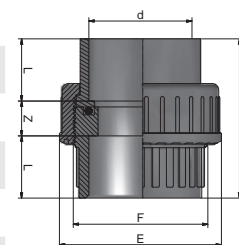

## PSPVF

### PVC-u Solvent Cement Fittings Metric Elbow 90° Plain

Nominal size (d)	Code	L	Z	E	PN	Price each
16	RFIGOI0160	14	9	23	16	£2.22
20	RFIGOI0200	16	11	27	16	£2.89
25	RFIGOI0250	19	13	33	16	£3.33
32	RFIGOI0320	22	17	41	16	£4.08
40	RFIGOI0400	26	22	50	16	£7.27
50	RFIGOI0500	30	26	60	16	£9.22
63	RFIGOI0630	38	32	74	16	£14.16
75	RFIGOI0750	45	39	89	16	£32.44
90	RFIGOI0900	51	46	105	16	£41.44
110	RFIGOI1100	61	56	130	16	£62.90
125	RFIGOI1250	72	63	145	16	£121.91
140	RFIGOI1400	79	73	164	16	£171.36
160	RFIGOI1600	89	81	187	16	£243.94
200	RFIGOI2000	106	102	230	16	£492.58
225	RFIGOI2250	119	114	257	16	£676.94
250	RFIGOI2500	132	185	285	10	£1,632.99
280	RFIGOI2800	147	210	325	10	£1,786.88
315	RFIGOI3150	164	236	359	10	£2,140.80

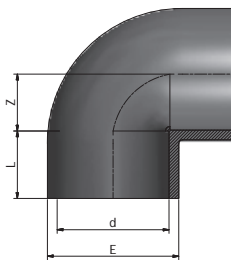

**PSPVF**

**PVC-u Solvent Cement Fittings Metric**  
Elbow 45° Plain

Nominal size (d)	Code	L	Z	E	PN	Price each
16	<b>RFIGYI0160</b>	14	6	23	16	£4.31
20	<b>RFIGYI0200</b>	17	4	28	16	£4.71
25	<b>RFIGYI0250</b>	19	7	33	16	£5.11
32	<b>RFIGYI0320</b>	22	8	41	16	£5.84
40	<b>RFIGYI0400</b>	26	10	50	16	£8.56
50	<b>RFIGYI0500</b>	32	11	62	16	£9.30
63	<b>RFIGYI0630</b>	37	14	75	16	£16.02
75	<b>RFIGYI0750</b>	43	17	88	16	£30.24
90	<b>RFIGYI0900</b>	51	22	106	16	£37.60
110	<b>RFIGYI1100</b>	61	24	128	16	£79.70
125	<b>RFIGYI1250</b>	69	27	145	16	£122.74
140	<b>RFIGYI1400</b>	77	30	163	16	£158.89
160	<b>RFIGYI1600</b>	87	35	185	16	£185.71
200	<b>RFIGYI2000</b>	106	42	232	16	£398.59
225	<b>RFIGYI2250</b>	119	48	258	16	£512.55
250	<b>RFIGYI2500</b>	131	57	288	10	£1,212.84
280	<b>RFIGYI2800</b>	146	62	320	10	£1,317.77
315	<b>RFIGYI3150</b>	164	66	359	10	£2,259.79

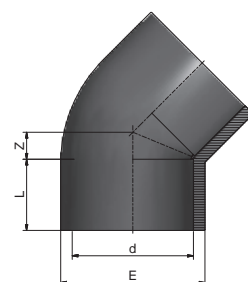

PVCu - Metric

**PSPVF**

**PVC-u Solvent Cement Fittings Metric**  
Bend 90° Short Radius

Nominal size (d)	Code	L	Z	E	PN	Price each
20	<b>RFICUI0200</b>	16	40	30	16	£11.54
25	<b>RFICUI0250</b>	19	50	35	16	£18.98
32	<b>RFICUI0320</b>	22	64	42	16	£23.06
40	<b>RFICUI0400</b>	26	80	51	16	£36.10
50	<b>RFICUI0500</b>	31	100	63	16	£45.70
63	<b>RFICUI0630</b>	38	126	77	16	£62.38
75	<b>RFICUI0750</b>	44	150	94	16	£109.18
90	<b>RFICUI0900</b>	51	180	113	16	£162.48
110	<b>RFICUI1100</b>	61	220	137	16	£239.15

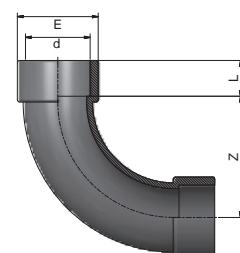

## PSPVF

### PVC-u Solvent Cement Fittings Metric Tee 90° Plain

Nominal size (d)	Code	L	Z	E	PN	Price each
16	RFITII0160	14	9	23	16	£2.62
20	RFITII0200	17	11	27	16	£3.33
25	RFITII0250	19	14	33	16	£4.00
32	RFITII0320	22	17	42	16	£5.42
40	RFITII0400	26	21	51	16	£7.64
50	RFITII0500	31	26	62	16	£12.07
63	RFITII0630	38	33	76	16	£18.13
75	RFITII0750	44	39	89	16	£38.05
90	RFITII0900	51	47	106	16	£52.35
110	RFITII1100	61	56	130	16	£80.19
125	RFITII1250	72	64	145	16	£163.88
140	RFITII1400	79	72	162	16	£250.93
160	RFITII1600	89	81	188	16	£275.07
200	RFITII2000	106	101	232	10	£575.53
225	RFITII2250	119	114	258	10	£624.29
250	RFITII2500	131	128	287	10	£1,229.45
280	RFITII2800	146	144	319	10	£1,343.32
315	RFITII3150	164	162	360	10	£2,570.34

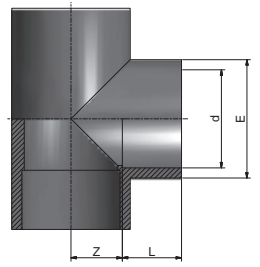

## PSPVF

### PVC-u Solvent Cement Fittings Metric Tee 45° Plain

Nominal size (d)	Code	L	Z1	Z2	E	PN	Price each
20	RFITYI0200	16	7	29	27.5	16	£15.06
25	RFITYI0250	19	7	36	33.5	16	£16.10
32	RFITYI0320	22	8	44	42	16	£18.13
40	RFITYI0400	26	10	54	51	16	£22.26
50	RFITYI0500	31	12	65	61	16	£28.01
63	RFITYI0630	38	14	80	74.5	16	£43.39
75	RFITYI0750	44	20	94	89	16	£215.40
90	RFITYI0900	51	21	113	106	10	£336.74
110	RFITYI1100	61	23	143	129	10	£690.62

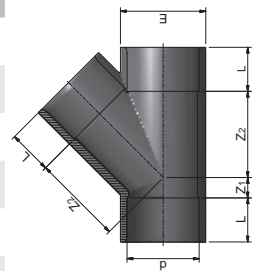

**PSPVF**

**PVC-u Solvent Cement Fittings Metric**  
Cross 90° Plain

Nominal size (d)	Code	L	Z	E	PN	Price each
20	<b>RFICXI0200</b>	16	11	28	16	£11.89
25	<b>RFICXI0250</b>	19	14	34	16	£14.95
32	<b>RFICXI0320</b>	22	17	42	16	£17.81
40	<b>RFICXI0400</b>	26	21	51	16	£26.17
50	<b>RFICXI0500</b>	31	26	61	16	£32.37
63	<b>RFICXI0630</b>	38	33	75	16	£48.39

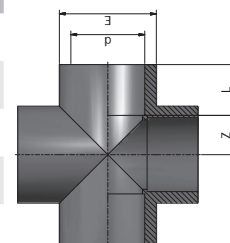

**PSPVF**

**PVC-u Solvent Cement Fittings Metric**  
Tee 90° Reduced on Branch Plain

Nominal size	d	Code	d1	L	L1	Z	Z1	E	E1	PN	Price each
20 x 16	20	<b>RFITRI020A</b>	16	16	14	11	11	28	23	16	£2.82
25 x 16	25	<b>RFITRI025A</b>	16	19	16	14	14	33	24	16	£3.33
25 x 20	25	<b>RFITRI025B</b>	20	19	16	14	14	34	28	16	£4.00
32 x 16	32	<b>RFITRI032A</b>	16	22	14	17	17	42	24	16	£5.35
32 x 20	32	<b>RFITRI032B</b>	20	23	16	18	18	42	28	16	£5.35
32 x 25	32	<b>RFITRI032C</b>	25	23	19	18	18	42	34	16	£5.35
40 x 20	40	<b>RFITRI040B</b>	20	27	16	21	21	50	28	16	£7.76
40 x 25	40	<b>RFITRI040C</b>	25	26	19	21	21	51	34	16	£7.76
40 x 32	40	<b>RFITRI040D</b>	32	27	22	21	21	50	42	16	£7.76
50 x 20	50	<b>RFITRI050B</b>	20	31	16	26	26	61	28	16	£12.07
50 x 25	50	<b>RFITRI050C</b>	25	31	19	26	26	61	34	16	£12.07
50 x 32	50	<b>RFITRI050D</b>	32	31	22	26	26	61	42	16	£12.07
50 x 40	50	<b>RFITRI050E</b>	40	31	26	26	26	61	51	16	£12.07
63 x 25	63	<b>RFITRI063C</b>	25	38	19	33	33	75	34	16	£18.13
63 x 32	63	<b>RFITRI063D</b>	32	38	22	33	33	74	42	16	£18.13
63 x 40	63	<b>RFITRI063E</b>	40	38	26	33	33	74	51	16	£18.13
63 x 50	63	<b>RFITRI063F</b>	50	38	31	33	33	74	60	16	£18.13
75 x 40	75	<b>RFITRI075E</b>	40	45	26	39	39	90	51	16	£31.93
75 x 50	75	<b>RFITRI075F</b>	50	45	31	39	39	90	61	16	£31.93
75 x 63	75	<b>RFITRI075G</b>	63	45	38	39	39	90	74	16	£31.93
90 x 50	90	<b>RFITRI090F</b>	50	51	31	47	47	106	61	16	£52.35
90 x 63	90	<b>RFITRI090G</b>	63	51	39	47	47	106	75	16	£52.35
90 x 75	90	<b>RFITRI090H</b>	75	51	43	47	47	106	90	16	£52.35

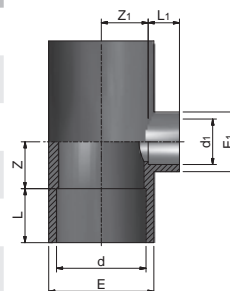

PVCu - Metric

## PSPVF

### PVC-u Solvent Cement Fittings Metric Tee 90° Reduced on Branch Plain

Nominal size	d	Code	d1	L	L1	Z	Z1	E	E1	PN	
110 x 50	110	<b>RFITRI110F</b>	50	61	31	57	57	129	61	16	£79.50
110 x 63	110	<b>RFITRI110G</b>	63	61	34	56	56	130	75	16	£79.50
110 x 75	110	<b>RFITRI110H</b>	75	61	44	56	56	130	90	16	£79.50
110 x 90	110	<b>RFITRI110I</b>	90	61	51	56	56	130	106	16	£79.50
160 x 90	160	<b>RFITRI160I</b>	90	89	51	81	81	187	106	16	£272.67
160 x 110	160	<b>RFITRI160L</b>	110	89	61	81	81	187	130	16	£272.67
160 x 140	160	<b>RFITRI160N</b>	140	86	76	82	82	184	163	16	£272.67

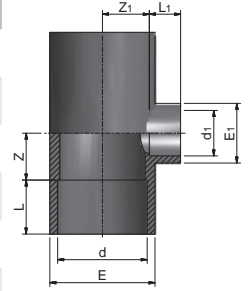

## PSPVF

### PVC-u Solvent Cement Fittings Metric Reducing Socket Plain

Nominal size	d	Code	d1	d2	L	L1	L2	Z	E	PN	Price each
20 x 16	20	<b>RFIMRI020A</b>	25	16	16	19	14	22	23	16	£2.23
25 x 20	25	<b>RFIMRI025B</b>	32	20	19	22	16	25	28	16	£2.37
32 x 25	32	<b>RFIMRI032C</b>	40	25	22	24	19	30	33	16	£3.64
40 x 32	40	<b>RFIMRI040D</b>	50	32	28	31	22	37	41	16	£6.03
50 x 40	50	<b>RFIMRI050E</b>	63	40	32	38	26	44	50	16	£8.81
63 x 40	63	<b>RFIMRI063E</b>	75	40	38	44	26	56	50	16	£11.85
63 x 50	63	<b>RFIMRI063F</b>	75	50	38	44	32	50	60	16	£11.85
75 x 63	75	<b>RFIMRI075G</b>	90	63	44	51	38	55.1	75	16	£27.88
90 x 75	90	<b>RFIMRI090H</b>	110	75	51	61	44	66.7	88	16	£40.04
110 x 90	110	<b>RFIMRI110I</b>	125	90	61	69	51	78	106	16	£54.29
125 x 110	125	<b>RFIMRI125L</b>	140	110	69	76	61	86	129	16	£95.15
140 x 110	140	<b>RFIMRI140L</b>	160	110	76	86	61	94	129	16	£115.28

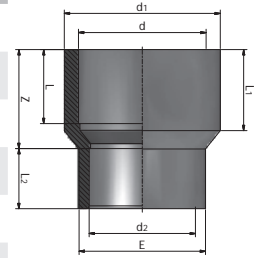

**PSPVF**

**PVC-u Solvent Cement Fittings Metric**  
Reducing Bush Plain

Nominal size	d	Code	d1	L	Z	PN	Price each
20 x 16	20	<b>RFIRCI020A</b>	16	16	2	16	£2.18
25 x 16	25	<b>RFIRCI025A</b>	16	19	5	16	£2.50
25 x 20	25	<b>RFIRCI025B</b>	20	19	3	16	£2.50
32 x 16	32	<b>RFIRCI032A</b>	16	22	8	16	£3.12
32 x 20	32	<b>RFIRCI032B</b>	20	22	6	16	£3.12
32 x 25	32	<b>RFIRCI032C</b>	25	22	3	16	£3.12
40 x 20	40	<b>RFIRCI040B</b>	20	26	10	16	£4.22
40 x 25	40	<b>RFIRCI040C</b>	25	27	8	16	£4.22
40 x 32	40	<b>RFIRCI040D</b>	32	26	4	16	£4.22
50 x 25	50	<b>RFIRCI050C</b>	25	31	12	16	£5.02
50 x 32	50	<b>RFIRCI050D</b>	32	31	9	16	£5.02
50 x 40	50	<b>RFIRCI050E</b>	40	31	5	16	£5.02
63 x 32	63	<b>RFIRCI063D</b>	32	38	16	16	£6.51
63 x 40	63	<b>RFIRCI063E</b>	40	37	11	16	£6.51
63 x 50	63	<b>RFIRCI063F</b>	50	37	6	16	£6.68
75 x 40	75	<b>RFIRCI075E</b>	40	44	18	16	£12.43
75 x 50	75	<b>RFIRCI075F</b>	50	44	13	16	£12.43
75 x 63	75	<b>RFIRCI075G</b>	63	44	6	16	£12.43
90 x 50	90	<b>RFIRCI090F</b>	50	51	20	16	£21.54
90 x 63	90	<b>RFIRCI090G</b>	63	52	14	16	£21.54
90 x 75	90	<b>RFIRCI090H</b>	75	52	8	16	£21.54
110 x 63	110	<b>RFIRCI110G</b>	63	61	23	16	£29.62
110 x 75	110	<b>RFIRCI110H</b>	75	61	17	16	£30.57
110 x 90	110	<b>RFIRCI110I</b>	90	60	9	16	£30.57
125 x 75	125	<b>RFIRCI125H</b>	75	69	25	16	£50.05
125 x 90	125	<b>RFIRCI125I</b>	90	69	18	16	£50.05
125 x 110	125	<b>RFIRCI125L</b>	110	69	8	16	£50.05
140 x 90	140	<b>RFIRCI140I</b>	90	76	25	16	£65.05
140 x 110	140	<b>RFIRCI140L</b>	110	76	15	16	£65.05
140 x 125	140	<b>RFIRCI140M</b>	125	77	8	16	£65.05
160 x 110	160	<b>RFIRCI160L</b>	110	87	26	16	£87.91
160 x 125	160	<b>RFIRCI160M</b>	125	88	17	16	£87.91
160 x 140	160	<b>RFIRCI160N</b>	140	87	11	16	£87.91
200 x 160	200	<b>RFIRCI200O</b>	160	107	21	10	£174.75
225 x 160	225	<b>RFIRCI225O</b>	160	119	33	10	£255.79
225 x 200	225	<b>RFIRCI225P</b>	200	119	13	10	£255.79
250 x 160	250	<b>RFIRCI250O</b>	160	132	45	10	£541.59

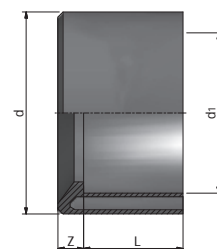



## PSPVF

### PVC-u Solvent Cement Fittings Metric Reducing Bush Plain

Nominal size	d	Code	d1	L	Z	PN	Price each
250 x 200	250	<b>RFIRCI250P</b>	200	134	27	10	£541.59
250 x 225	250	<b>RFIRCI250Q</b>	225	134	14	12	£541.59
280 x 225	280	<b>RFIRCI280Q</b>	225	147	27	10	£506.65
315 x 200	315	<b>RFIRCI315P</b>	200	165	58	10	£861.57
315 x 225	315	<b>RFIRCI315Q</b>	225	165	45	10	£861.57
315 x 250	315	<b>RFIRCI315R</b>	250	165	33	10	£861.57

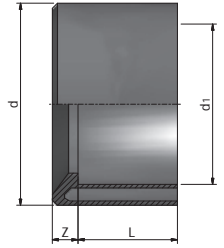

## PSPVF

### PVC-u Solvent Cement Fittings Metric Cap Plain

Nominal size (d)	Code	L	H	E	PN	Price each
16	<b>RFICAI0160</b>	17	22	23	16	£1.78
20	<b>RFICAI0200</b>	16	30	27	16	£2.00
25	<b>RFICAI0250</b>	19	31	33	16	£2.36
32	<b>RFICAI0320</b>	23	36	41	16	£2.70
40	<b>RFICAI0400</b>	27	43	51	16	£4.16
50	<b>RFICAI0500</b>	33	49	61	16	£5.84
63	<b>RFICAI0630</b>	38	57	75	16	£8.47
75	<b>RFICAI0750</b>	45	67	88	16	£22.86
90	<b>RFICAI0900</b>	52	81	105	16	£25.99
110	<b>RFICAI1100</b>	63	97	128	16	£39.99
125	<b>RFICAI1250</b>	69	99	145	16	£65.97
140	<b>RFICAI1400</b>	77	107	161	16	£76.72
160	<b>RFICAI1600</b>	87	126	182	16	£113.09
200	<b>RFICAI2000</b>	106	166	231	10	£233.98
225	<b>RFICAI2250</b>	118	173	247	10	£320.35

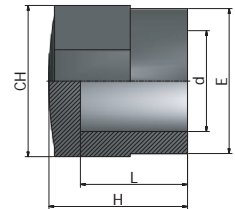
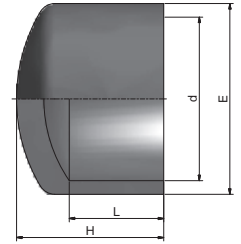

## PSPVF

### PVC-u Solvent Cement Fittings Metric Adaptor Socket Plain

Nominal size	d	Code	d1	L	L1	Z	E	PN	Price each
½" x 20	½"	RFBMAB0200	20	17	16	4	26	16	£3.07
¾" x 25	¾"	RFBMAB0250	25	20	19	4	33	16	£3.25
1" x 32	1"	RFBMAB0320	32	23	22	4	41	16	£4.02
1¼" x 40	1¼"	RFBMAB0400	40	27	26	4	51	16	£6.11
1½" x 50	1½"	RFBMAB0500	50	32	31	4	60	16	£8.71
2" x 63	2"	RFBMAB0630	63	38	38	3	74	16	£19.82
3" x 90	3"	RFBMAB0900	90	51	50	6	105	16	£35.57
4" x 110	4"	RFBMAB1100	110	63	61	8	128	16	£57.92
6" x 160	6"	RFBMAB1600	160	90	86	12	182	16	£143.30

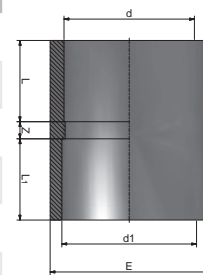

## PSPVF

### PVC-u Solvent Cement Fittings Metric Adaptor Union

Nominal size	d	Code	Rp	L1	L2	Z	H	E	F	PN	Price each
½" x 20	20	RFBBOB0200	½"	16	15	14	45	43	1"	16	£17.87
¾" x 25	25	RFBBOB0250	¾"	19	16.3	15.7	51	54	1¼"	16	£20.07
1" x 32	32	RFBBOB0320	1"	22	19.5	15.5	57	60	1½"	16	£30.98
1¼" x 40	40	RFBBOB0400	1¼"	27	21.4	19.6	68	75	2"	16	£38.90
1½" x 50	50	RFBBOB0500	1½"	31	21.4	27.6	80	81	2¼"	16	£49.75
2" x 63	63	RFBBOB0630	2"	38	25.7	34.3	98	99	2¾"	16	£58.40
3" x 90	90	RFBBOB0900	3"	51	33.3	40.7	125	134	4"	16	£231.22
4" x 110	110	RFBBOB1100	4"	61	39.3	44.7	145	163	5"	16	£251.46

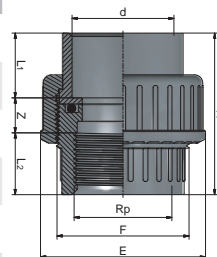

# PVC-u Flanges Metric

**PSPVF**
**PVC-u Flanges Metric**  
 Stub Flange (Serrated Face) Plain

Nominal size (d)	d1	Code	L	S	Z	E	PN	Price each
20	27	<b>RFIQR10200</b>	16	3	3	34	16	£2.57
25	33	<b>RFIQR10250</b>	19	3	4	41	16	£2.70
32	41	<b>RFIQR10320</b>	22	7	4	50	16	£3.36
40	50	<b>RFIQR10400</b>	26	8	3	61	16	£5.19
50	61	<b>RFIQR10500</b>	32	9	4	73	16	£7.80
63	76	<b>RFIQR10630</b>	38	10	4	90	16	£13.86
75	90	<b>RFIQR10750</b>	44	10	5	106	16	£22.73
90	108	<b>RFIQR10900</b>	52	11	4	125	16	£25.93
110	131	<b>RFIQR11100</b>	62	12	5	149	16	£36.38
125	148	<b>RFIQR11250</b>	70	12	6	169	16	£71.54
140	165	<b>RFIQR11400</b>	77	13	8	189	16	£76.61
160	188	<b>RFIQR11600</b>	87	13	7	214	16	£85.81
200	231	<b>RFIQR12000</b>	106	19	7	254	10	£163.51
225	248	<b>RFIQR12250</b>	119	20	9	273	10	£260.05
250	271	<b>RFIQR12500</b>	131	20	10	306	16	£305.85
280	307	<b>RFIQR12800</b>	147	32	14.5	327	10	£362.10
315	346	<b>RFIQR13150</b>	165	32	16	377	10	£557.45

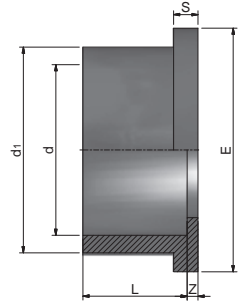
**PSPVF**
**PVC-u Flanges Metric**  
 Full Faced Flange Drilled to BS4504 NP10/16 Plain

Nominal size (d)	Code	L	S	f	i	Z	E	n° x M	PN	Price each
20	<b>RFIFFI0200</b>	16	11	14	65	5	95	4 x M12	16	£11.40
25	<b>RFIFFI0250</b>	19	12	14	75	5	105	4 x M12	16	£11.59
32	<b>RFIFFI0320</b>	22	14	14	85	5	115	4 x M12	16	£15.00
40	<b>RFIFFI0400</b>	26	15	18	100	5	142	4 x M16	16	£17.59
50	<b>RFIFFI0500</b>	31	16	18	110	5	152	4 x M16	16	£20.72
63	<b>RFIFFI0630</b>	38	18	18	125	5	165	4 x M16	16	£26.31
75	<b>RFIFFI0750</b>	44	19	18	145	6	185	4 x M16	16	£43.32
90	<b>RFIFFI0900</b>	51	20	18	160	7	200	8 x M16	16	£48.96
110	<b>RFIFFI1100</b>	63	22	18	180	8	220	8 x M16	16	£67.95

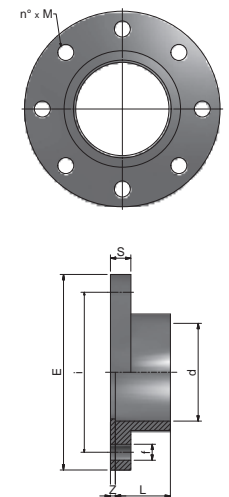

**PSPVF**

**PVC-u Flanges Metric**  
Blanking Flange drilled to BS4504 NP10/16.

Nominal size (d)	Code	S	f	i	E	n° x M	PN	Price each
20	<b>RFIFCI0200</b>	11	14	65	95	4 x M12	20	£37.94
25	<b>RFIFCI0250</b>	12	14	75	105	4 x M12	25	£43.17
32	<b>RFIFCI0320</b>	14	14	85	115	4 x M12	32	£55.67
40	<b>RFIFCI0400</b>	15	18	100	141	4 x M16	40	£58.63
50	<b>RFIFCI0500</b>	16	18	110	150	4 x M16	50	£63.37
63	<b>RFIFCI0630</b>	18	18	125	165	4 x M16	63	£70.94
75	<b>RFIFCI0750</b>	19	18	145	185	4 x M16	75	£106.25
90	<b>RFIFCI0900</b>	20	18	160	200	8 x M16	90	£125.39
110	<b>RFIFCI1100</b>	22	18	180	220	8 x M16	110	£161.28
125	<b>RFIFCI1250</b>	24	18	190	230	8 x M16	125	£170.77
140	<b>RFIFCI1400</b>	26	18	210	250	8 x M16	140	£252.00
160	<b>RFIFCI1600</b>	28	22	240	285	8 x M20	160	£283.14
200	<b>RFIFCI2000</b>	30	22	295	345	8 x M20	200	£316.62
225	<b>RFIFCI2250</b>	30	22	295	345	8 x M20	225	£525.00

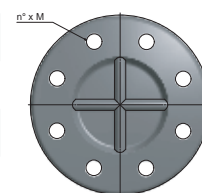
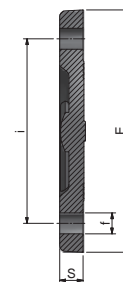

PVCu - Metric

# PVC-u Adaptor Fittings Metric

**PSPVF**
**PVC-u Adaptor Fittings Metric**  
 Socket Plain/BSP Female Threaded

Nominal size	d	Code	Rp	L1	L2	CH	Z	E	PN	Price each
16 x 3/8"	16	<b>RFPMAP016A</b>	3/8"	14	11.4	24	6	23	16	£4.61
20 x 1/2"	20	<b>RFPMAP020B</b>	1/2"	17	15	28	4	28	16	£4.98
25 x 3/4"	25	<b>RFPMAP025C</b>	3/4"	20	16.3	34	6	34	16	£5.40
32 x 1"	32	<b>RFPMAP032D</b>	1"	23	19.1	42	6.6	42	16	£6.84
40 x 1 1/4"	40	<b>RFPMAP040E</b>	1 1/4"	28	21.4	55	7	51	16	£10.67
50 x 1 1/2"	50	<b>RFPMAP050F</b>	1 1/2"	32	21.4	65	7	61	16	£12.92
63 x 2"	63	<b>RFPMAP063G</b>	2"	39	25.7	75	7	75	16	£17.15
75 x 2 1/2"	75	<b>RFPMAP075H</b>	2 1/2"	44	30.2	90	8	89	16	£52.65
90 x 3"	90	<b>RFPMAP090I</b>	3"	51	33.3	110	9	106	16	£56.26
110 x 4"	110	<b>RFPMAP110L</b>	4"	61	39.3	130	10	129	16	£70.32

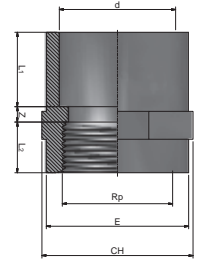
**PSPVF**
**PVC-u Adaptor Fittings Metric**  
 Socket Plain/BSP Female Threaded with Stainless Steel Reinforcing Ring

Nominal size	d	Code	Rp	L1	L2	CH	Z	E	PN	Price each
20 x 1/2"	20	<b>RFRMER0200</b>	1/2"	16	15	30	4	28	16	£8.41
25 x 3/4"	25	<b>RFRMER0250</b>	3/4"	19	16	36	6	34	16	£8.86
32 x 1"	32	<b>RFRMER0320</b>	1"	22	19	46	6.6	42	16	£10.48
40 x 1 1/4"	40	<b>RFRMER0400</b>	1 1/4"	27	21	55	7	51	16	£15.07
50 x 1 1/2"	50	<b>RFRMER0500</b>	1 1/4"	32	21	65	7	61	16	£17.77
63 x 2"	63	<b>RFRMER0630</b>	2"	39	26	80	7	75	16	£22.49

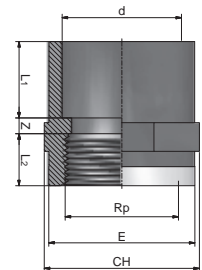

**PSPVF**

**PVC-u Adaptor Fittings Metric**  
Spigot Plain/BSP Female Threaded

Nominal size	d	Code	Rp	L1	L2	CH	H	PN	Price each
16 x 3/8"	16	<b>RFPAFP016A</b>	3/8"	14	11.4	24	34	16	£5.52
20 x 1/2"	20	<b>RFPAFP020B</b>	1/2"	16	15	30	40	16	£5.68
20 x 3/4"	20	<b>RFPAFP020C</b>	3/4"	16	16.3	36	42	16	£5.68
25 x 1/2"	25	<b>RFPAFP025B</b>	1/2"	19	15	30	44	16	£6.77
25 x 3/4"	25	<b>RFPAFP025C</b>	3/4"	19	16.3	36	45	16	£6.77
25 x 1"	25	<b>RFPAFP025D</b>	1"	19	19.1	46	48	16	£6.77
32 x 3/4"	32	<b>RFPAFP032C</b>	3/4"	22	16.3	36	48	16	£8.12
32 x 1"	32	<b>RFPAFP032D</b>	1"	22	19.1	46	51	16	£8.12
40 x 1"	40	<b>RFPAFP040D</b>	1"	26	19.1	46	55	16	£9.48
40 x 1 1/4"	40	<b>RFPAFP040E</b>	1 1/4"	26	21.4	55	58	16	£9.48
50 x 1 1/2"	50	<b>RFPAFP050F</b>	1 1/2"	31	21.4	65	64	16	£16.36
50 x 2"	50	<b>RFPAFP050G</b>	2"	31	25.7	75	68	16	£16.36
63 x 2"	63	<b>RFPAFP063G</b>	2"	38	25.7	75	75	16	£19.96
75 x 2"	75	<b>RFPAFP075G</b>	2"	44	25.7	75	85	16	£32.94
75 x 2 1/2"	75	<b>RFPAFP075H</b>	2 1/2"	44	30.2	90	88	16	£32.94
75 x 3"	75	<b>RFPAFP075I</b>	3"	44	33.3	115	91	16	£32.94
90 x 2 1/2"	90	<b>RFPAFP090H</b>	2 1/2"	51	30.2	95	95	16	£47.33
90 x 3"	90	<b>RFPAFP090I</b>	3"	51	33.3	115	98	16	£41.49
90 x 4"	90	<b>RFPAFP090L</b>	4"	51	39.3	130	104	16	£47.33
110 x 3"	110	<b>RFPAFP110I</b>	3"	61	33.3	115	109	16	£59.86
110 x 4"	110	<b>RFPAFP110L</b>	4"	61	39.3	130	115	16	£59.86

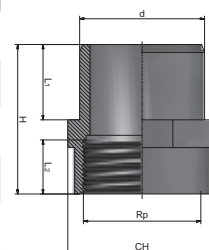

PVCu - Metric

**PSPVF**

**PVC-u Adaptor Fittings Metric**  
Spigot Plain/BSP Female Threaded with Stainless Steel Reinforcing Ring

Nominal Size (d x Rp)	d	Code	Rp	L1	L2	CH	H	E	PN	Price each
20 x 1/2"	20	<b>RFRAER0200</b>	1/2"	16	15	30	40	28	16	£9.16
25 x 3/4"	25	<b>RFRAER0250</b>	3/4"	19	16.3	36	45	34	16	£10.40
32 x 1"	32	<b>RFRAER0320</b>	1"	22	19.1	46	51	42	16	£11.87
40 x 1 1/4"	40	<b>RFRAER0400</b>	1 1/4"	26	21.4	55	58	51	16	£13.92
50 x 1 1/2"	50	<b>RFRAER0500</b>	1 1/2"	31	21.4	65	64		16	£21.38
63 x 2"	63	<b>RFRAER0630</b>	2"	38	25.7	80	75	72	16	£25.07

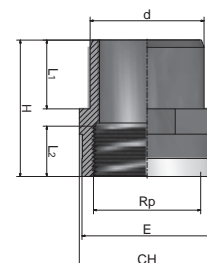

## PSPVF

### PVC-u Adaptor Fittings Metric Union Plain/BSP Female Threaded

Nominal size	d	Code	Rp	L1	L2	F	Z	H	E	PN	Price each
16 x 3/8"	16	RFPBOP016A	3/8"	14	11.4	3/4"	16.6	42	34	16	£16.02
20 x 1/2"	20	RFPBOP020B	1/2"	16	15	1"	14	45	43	16	£18.38
25 x 3/4"	25	RFPBOP025C	3/4"	19	16.3	1 1/4"	15.7	51	54	16	£19.59
32 x 1"	32	RFPBOP032D	1"	22	19.5	1 1/2"	15.5	57	60	16	£25.50
40 x 1 1/4"	40	RFPBOP040E	1 1/4"	27	21.4	2"	19.6	68	75	16	£29.37
50 x 1 1/2"	50	RFPBOP050F	1 1/2"	31	21.4	2 1/4"	27.6	80	81	16	£42.67
63 x 2"	63	RFPBOP063G	2"	38	25.7	2 3/4"	34.3	98	99	16	£64.21
75 x 2 1/2"	75	RFPBOP075H	2 1/2"	44	30.2	3 1/2"	35.8	110	120	16	£100.54
90 x 3"	90	RFPBOP090I	3"	51	33.3	4"	40.7	125	134	16	£138.00
110 x 4"	110	RFPBOP110L	4"	61	39.3	5"	44.7	145	163	16	£167.96

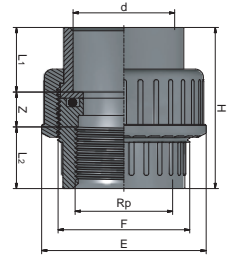

## PSPVF

### PVC-u Adaptor Fittings Metric Composite Union Plain Metric/BSP Male Brass Taper Threaded with Plastic Nut

Nominal size	d	Code	G	L1	L2	F	CH	H	E	PN	Price each
20 x 1/2"	20	RGRPMC0200	1/2"	17	13	1"	30	61	43	16	£47.98
25 x 3/4"	25	RGRPMC0250	3/4"	19	14	1 1/4"	36	68	54	16	£61.40
32 x 1"	32	RGRPMC0320	1"	23	18	1 1/2"	46	77	60	16	£80.42
40 x 1 1/4"	40	RGRPMC0400	1 1/4"	27	21	2"	55	87	75	16	£126.24
50 x 1 1/2"	50	RGRPMC0500	1 1/2"	37	21	2 1/4"	65	95	81	16	£153.29
63 x 2"	63	RGRPMC0630	2"	41	21	2 3/4"	80	108	99	16	£234.98

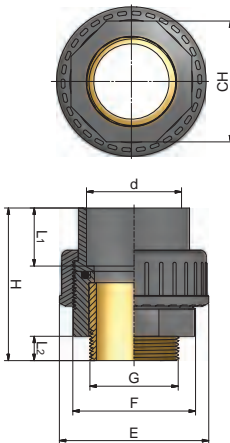

## PSPVF

### PVC-u Adaptor Fittings Metric Composite Union Plain Metric/BSP Male Brass Taper Threaded

Nominal size	d	Code	G	L1	L2	CH1	CH2	Z1	Z2	H	PN	Price each
20 x 1/2"	20	RGRBNG020B	1/2"	16	13.2	25	44	3	19.8	52	16	£48.95
25 x 3/4"	25	RGRBNG025C	3/4"	19	14.5	31	46	3	23.5	60	16	£62.66
32 x 1"	32	RGRBNG032D	1"	22	16.8	38	55	3	24.2	66	16	£82.07
40 x 1 1/4"	40	RGRBNG040E	1 1/4"	27	21	47	65	3	28	79	16	£128.81
50 x 1 1/2"	50	RGRBNG050F	1 1/2"	31	21	53	72	4	29	85	16	£156.41
63 x 2"	63	RGRBNG063G	2"	38	23.4	66	88	4	31.6	97	16	£239.76
90 x 3"	90	RGRBNG090I	3"	51	27.2	95	121	5	42.8	126	16	£597.73

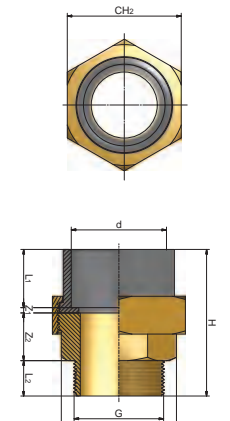



## PSPVF

### PVC-u Adaptor Fittings Metric

Composite Union Plain Metric/BSP Female Brass Taper Threaded with Plastic Nut

Nominal size	d	Code	Rp	L1	L2	CH	H	E	PN	Price each
20 x 1/2"	20	RGRPFC0200	1/2"	16	14	30	47	43	16	£44.29
25 x 3/4"	25	RGRPFC0250	3/4"	19	16	36	52	54	16	£59.51
32 x 1"	32	RGRPFC0320	1"	22	19	46	58	60	16	£76.66
40 x 1 1/4"	40	RGRPFC0400	1 1/4"	27	23	55	65	75	16	£120.76
50 x 1 1/2"	50	RGRPFC0500	1 1/2"	31	23	65	71	81	16	£143.05
63 x 2"	63	RGRPFC0630	2"	38	23	80	85	99	16	£224.38

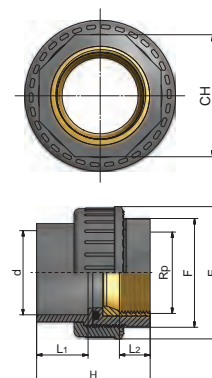

## PSPVF

### PVC-u Adaptor Fittings Metric

Composite Union Plain Metric/BSP Female Brass Threaded

Nominal size	d	Code	Rp	L1	L2	CH1	CH2	Z1	Z2	H	PN	Price each
20 x 1/2"	20	RGRBBG020B	1/2"	16	12	26	44	3	9	40	16	£45.19
25 x 3/4"	25	RGRBBG025C	3/4"	19	13	32	46	3	9	44	16	£60.71
32 x 1"	32	RGRBBG032D	1"	22	16	38	55	3	10	51	16	£78.23
40 x 1 1/4"	40	RGRBBG040E	1 1/4"	27	18	47	65	3	11	59	16	£123.21
50 x 1 1/2"	50	RGRBBG050F	1 1/2"	31	18	54	72	4	11	64	16	£145.96
63 x 2"	63	RGRBBG063G	2"	38	22	66	88	4	12	76	16	£228.95
90 x 3"	90	RGRBBG090I	3"	51	31	95	121	5	13	100	16	£500.24

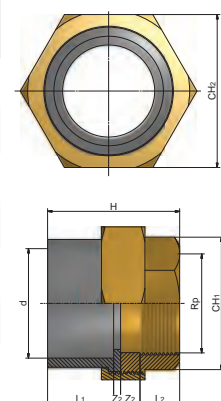

PVCu - Metric

## PSPVF

### PVC-u Adaptor Fittings Metric

Elbow 90° Plain/BSP Female Threaded

Nominal size	d	Code	Rp	L1	L2	Z1	Z2	E	PN	Price each
16 x 3/8"	16	RFPGOP016A	3/8"	14	11.4	9	12	23	16	£4.26
20 x 1/2"	20	RFPGOP020B	1/2"	16	15	11	13	28	16	£5.58
25 x 3/4"	25	RFPGOP025C	3/4"	19	16.3	14	17	34	16	£6.34
32 x 1"	32	RFPGOP032D	1"	22	19.1	17	21	42	16	£8.46
40 x 1 1/4"	40	RFPGOP040E	1 1/4"	26	21.4	21	27	51	16	£17.23
50 x 1 1/2"	50	RFPGOP050F	1 1/2"	31	21.4	26	37	61	16	£19.36
63 x 2"	63	RFPGOP063G	2"	38	25.7	33	46	75	16	£27.91
75 x 2 1/2"	75	RFPGOP075H	2 1/2"	44	30.2	39	53	89	16	£59.46
90 x 3"	90	RFPGOP090I	3"	51	33.3	47	65	106	16	£67.95
110 x 4"	110	RFPGOP110L	4"	61	39.3	57	79	129	16	£78.34

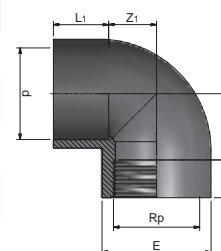

## PSPVF

### PVC-u Adaptor Fittings Metric Elbow 90° Plain/BSP Female with Stainless Steel Reinforcing Ring

Nominal size	d	Code	Rp	L1	L2	Z1	Z2	E	PN	Price each
20 x 1/2"	20	RFRGER0200	1/2"	16	15	11	13	28	16	£9.97
25 x 3/4"	25	RFRGER0250	3/4"	19	16.3	14	17	34	16	£11.25
32 x 1"	32	RFRGER0320	1"	22	19.1	17	21	42	16	£13.22
40 x 1 1/4"	40	RFRGER0400	1 1/4"	26	21.4	21	27	51	16	£18.61
50 x 1 1/2"	50	RFRGER0500	1 1/2"	31	21.4	26	37	61	16	£27.18
63 x 2"	63	RFRGER0630	2"	38	25.7	33	46	75	16	£37.03

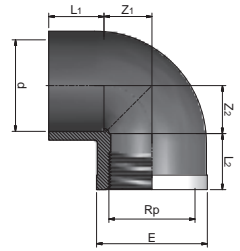

## PSPVF

### PVC-u Adaptor Fittings Metric Tee 90° Plain/BSP Female Threaded Branch

Nominal size	d	Code	Rp	L1	L2	Z1	Z2	E	PN	Price each
16 x 3/8"	16	RFPTIP016A	3/8"	14	11.4	9	12	23	16	£6.16
20 x 1/2"	20	RFPTIP020B	1/2"	16	15	11	13	28	16	£8.83
25 x 3/4"	25	RFPTIP025C	3/4"	19	16.3	14	17	34	16	£9.71
32 x 1"	32	RFPTIP032D	1"	22	19.1	17	21	42	16	£10.82
40 x 1 1/4"	40	RFPTIP040E	1 1/4"	27	21.4	21	27	51	16	£20.36
50 x 1 1/2"	50	RFPTIP050F	1 1/2"	31	21.4	26	37	61	16	£21.45
63 x 2"	63	RFPTIP063G	2"	38	25.7	33	47	75	16	£33.43
75 x 2 1/2"	75	RFPTIP075H	2 1/2"	44	30.2	39	53	89	16	£59.13
90 x 3"	90	RFPTIP090I	3"	51	33.3	47	65	106	16	£62.52
110 x 4"	110	RFPTIP110L	4"	61	39.3	57	79	129	16	£93.58

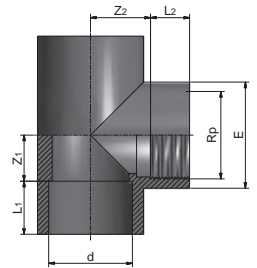

## PSPVF

### PVC-u Adaptor Fittings Metric Tee 90° Plain/BSP Female Threaded Branch with Stainless Steel Reinforcing Ring

Nominal size	d	Code	Rp	L1	L2	Z1	Z2	E	PN	Price each
20 x 1/2"	20	RFRTER0200	1/2"	16	15	11	13	28	16	£9.09
25 x 3/4"	25	RFRTER0250	3/4"	19	16.3	14	17	34	16	£11.77
32 x 1"	32	RFRTER0320	1"	22	19.1	17	21	42	16	£12.12
40 x 1 1/4"	40	RFRTER0400	1 1/4"	27	21.4	21	27	51	16	£19.41
50 x 1 1/2"	50	RFRTER0500	1 1/2"	31	21.4	26	37	61	16	£24.22
63 x 2"	63	RFRTER0630	2"	38	25.7	33	47	75	16	£33.16

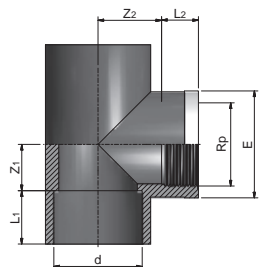

PVC-u - Metric

# PVC-u Adaptor Fittings Metric

**PSPVF**

**PVC-u Adaptor Fittings Metric**  
Adaptor Bush Metric Plain/BSP Female

Nominal Size (d x Rp)	d	Code	Rp	L min	Z max	H	PN	Price each
25 x 1/2"	25	RGRRCG025B	1/2"	15	4	19	16	£3.70
32 x 3/4"	32	RGRRCG032C	3/4"	16.3	5.7	22	16	£3.90
40 x 1"	40	RGRRCG040D	1"	19.1	6.9	26	16	£5.45
50 x 1 1/4"	50	RGRRCG050E	1 1/4"	21.4	9.6	31	16	£6.76
63 x 1 1/2"	63	RGRRCG063F	1 1/2"	21.4	16.6	38	16	£9.94
75 x 2"	75	RGRRCG075G	2"	25.7	18.3	44	16	£23.06
90 x 3"	90	RGRRCG090H	3"	30.2	20.8	51	16	£36.97
110 x 3"	110	RGRRCG110I	3"	33.3	27.7	61	16	£49.77

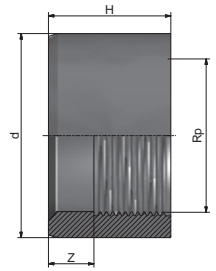

**PSPVF**

**PVC-u Adaptor Fittings Metric**  
Socket or Spigot Plain/BSP Male Threaded

Nominal size	d	Code	d1	G	L	L1	L2	CH	H	PN	Price each
12 x 16 x 3/8"	12	RFPAMP012A	16	3/8"	12	14	11.4	19	35	16	£3.48
16 x 20 x 3/8"	16	RFPAMP016A	20	3/8"	14	16	11.4	24	40	16	£3.48
16 x 20 x 1/2"	16	RFPAMP016B	20	1/2"	14	16	15	24	43	16	£3.48
20 x 25 x 3/8"	20	RFPAMP020A	25	3/8"	16	19	11.4	30	43	16	£3.60
20 x 25 x 1/2"	20	RFPAMP020B	25	1/2"	16	19	15	30	46	16	£3.60
20 x 25 x 3/4"	20	RFPAMP020C	25	3/4"	16	19	16.3	30	47	16	£3.60
25 x 32 x 1/2"	25	RFPAMP025B	32	1/2"	19	22	15	36	49	16	£4.20
25 x 32 x 3/4"	25	RFPAMP025C	32	3/4"	19	22	16.3	36	50	16	£4.20
25 x 32 x 1"	25	RFPAMP025D	32	1"	19	22	19.1	36	53	16	£4.20
32 x 40 x 3/4"	32	RFPAMP032C	40	3/4"	22	26	16.3	46	54	16	£5.15
32 x 40 x 1"	32	RFPAMP032D	40	1"	22	26	19.1	46	57	16	£5.15
32 x 40 x 1 1/4"	32	RFPAMP032E	40	1 1/4"	22	26	21.4	46	60	16	£5.15
40 x 50 x 1"	40	RFPAMP040D	50	1"	26	31	19.1	55	64	16	£10.35
40 x 50 x 1 1/4"	40	RFPAMP040E	50	1 1/4"	26	31	21.4	55	67	16	£10.35
40 x 50 x 1 1/2"	40	RFPAMP040F	50	1 1/2"	26	31	21.4	55	67	16	£10.35
50 x 63 x 1 1/4"	50	RFPAMP050E	63	1 1/4"	32	38	21.4	65	74	16	£15.00
50 x 63 x 1 1/2"	50	RFPAMP050F	63	1 1/2"	32	38	21.4	65	74	16	£15.00
50 x 63 x 2"	50	RFPAMP050G	63	2"	32	38	25.7	65	78	16	£15.00
63 x 75 x 1 1/2"	63	RFPAMP063F	75	1 1/2"	38	44	21.4	80	84	16	£23.99
63 x 75 x 2"	63	RFPAMP063G	75	2"	38	44	25.7	80	88	16	£23.99
63 x 75 x 2 1/2"	63	RFPAMP063H	75	2 1/2"	38	44	30.2	80	93	16	£23.99
75 x 90 x 2"	75	RFPAMP075G	90	2"	44	51	25.7	95	95	16	£42.32
75 x 90 x 2 1/2"	75	RFPAMP075H	90	2 1/2"	44	51	30.2	95	100	16	£42.32

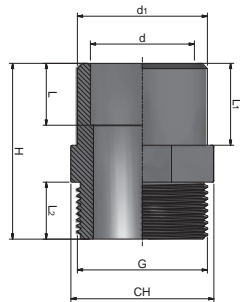

PVCu - Metric

**PSPVF**
**PVC-u Adaptor Fittings Metric**

Socket or Spigot Plain/BSP Male Threaded

Nominal size	d	Code	d1	G	L	L1	L2	CH	H	PN	Price each
75 x 90 x 3"	75	<b>RFPAMP075I</b>	90	3"	44	51	33.5	95	103	16	£42.32
90 x 110 x 2½"	90	<b>RFPAMP090H</b>	110	2½"	51	61	30.2	115	110	16	£48.31
90 x 110 x 3"	90	<b>RFPAMP090I</b>	110	3"	51	61	33.5	115	113	16	£48.31
90 x 110 x 4"	90	<b>RFPAMP090L</b>	110	4"	51	61	39.3	115	118	16	£48.31
110 x 125 x 3"	110	<b>RFPAMP110I</b>	125	3"	61	68.5	33.5	130	116	16	£62.68
110 x 125 x 4"	110	<b>RFPAMP110L</b>	125	4"	61	68.5	39.3	130	121	16	£62.68

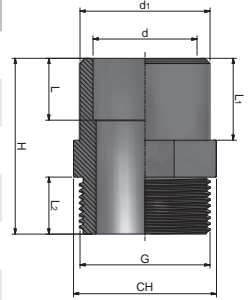
**PSPVF**
**PVC-u Adaptor Fittings Metric**

Tank Connector Metric/Imperial

Nominal size	Code	L1	L2	Z	E	Price each
20 x ½"	<b>RFITCI0200</b>	77	42	38	10	£15.33
25 x ¾"	<b>RFITCI0250</b>	77	42	42	10	£17.52
32 x 1"	<b>RFITCI0320</b>	103	55	55	10	£37.25
40 x 1 ¼"	<b>RFITCI0400</b>	121	70	65	10	£69.53
50 x 1 ½"	<b>RFITCI0500</b>	128	73	72	10	£80.61
63 x 2"	<b>RFITCI0630</b>	154	82	93	10	£88.08
90 x 3"	<b>RFITCI0900</b>	202	110	125	1	£149.71
110 x 4"	<b>RFITCI1100</b>	230	140	154	1	£160.66

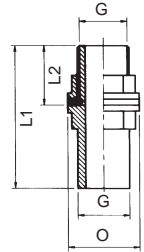

# PVC-u Valves



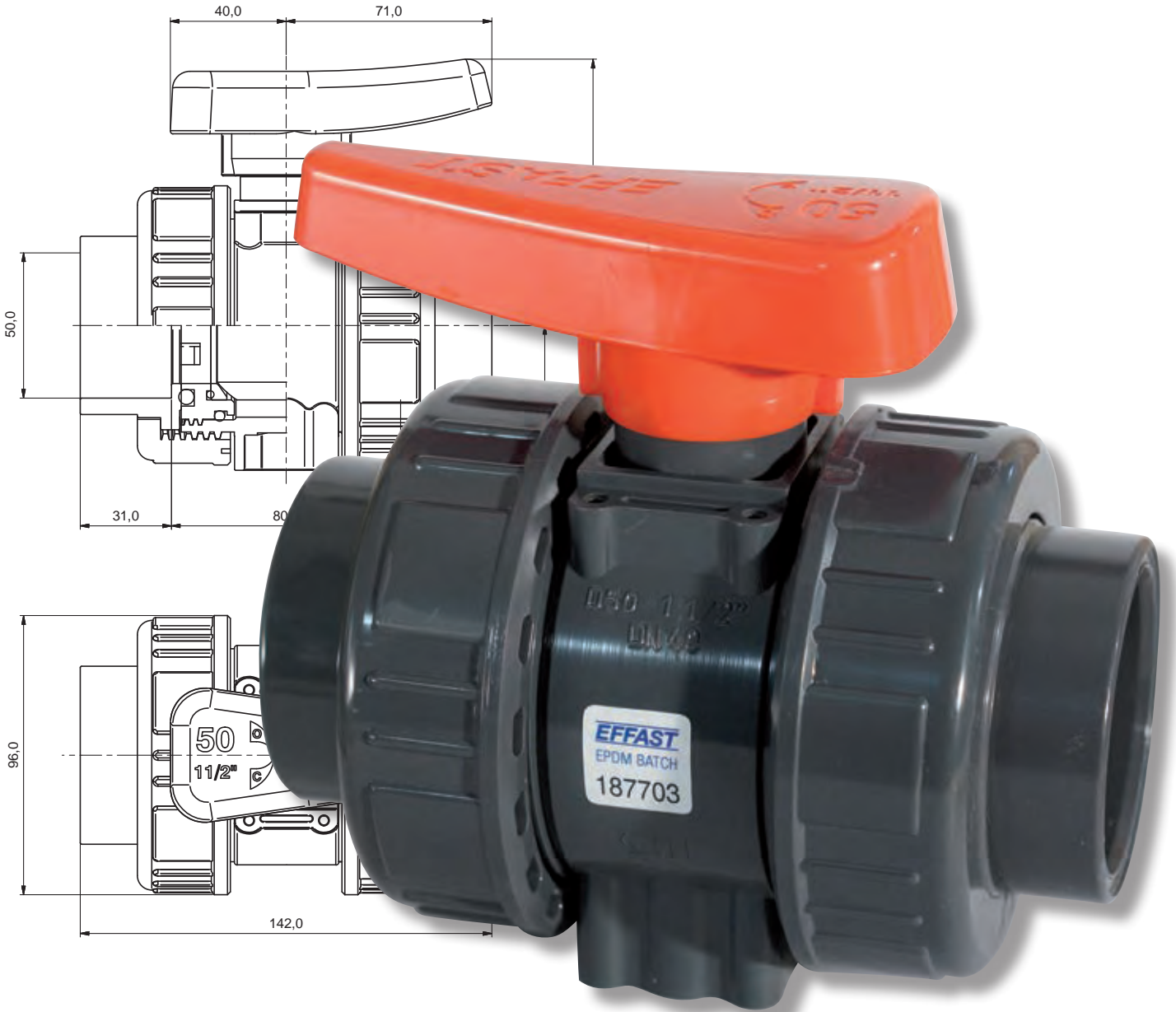

## PVC-u Industrial Manual Ball Valves

## Technical Features

- Floating full bore ball locked in place on both sides
- Fully round ball smoothed by special turning machine
- Machined stem seat
- Solvent welded sockets, threaded sockets
- PTFE ball seatings
- Nominal pressure (PN): 16 bar – 232 psi at 20°C
- Handle with combined key for the dismantling of the valve and the tightening of threaded gasket carrier
- Valves individually tested
- The valves are manufactured with a PVC-u fit for contact with potable water in accordance with regulations in U.K., Italy, France, Germany, Holland, and Scandinavian countries.

## Torque: PVC-u Ball Valves

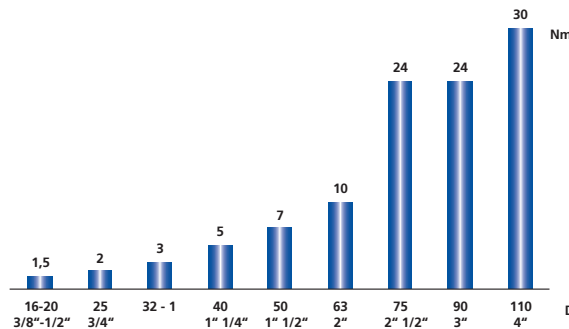

## Pressure Loss: PVC-u Ball Valves

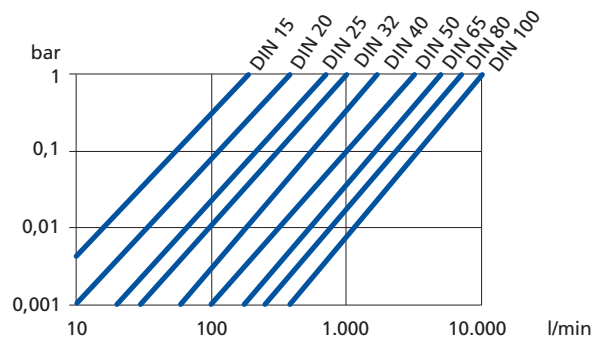

## Maximum Working Pressure: PVC-u Ball Valves

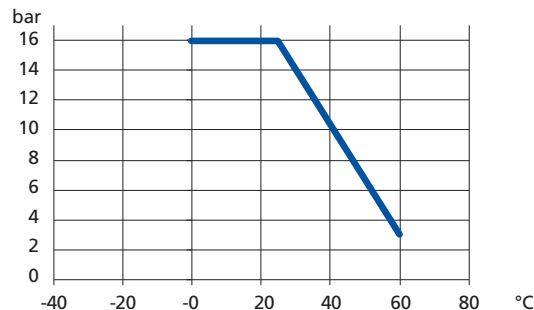

## Flow Rate: PVC-u Ball Valves

d	16/20	25	32	40	50	63	75	90	110
DN	15	20	25	32	40	50	65	80	100
L/m $\Delta P = 1$ Bar	190	380	700	1000	1700	3200	5000	7000	10000



# PVC-u Industrial Manual Ball Valves

Marine approval  
CE Approval



1. Ergonomic handle with integrated tool for removing of union bushings and adjusting the ball seat carrier

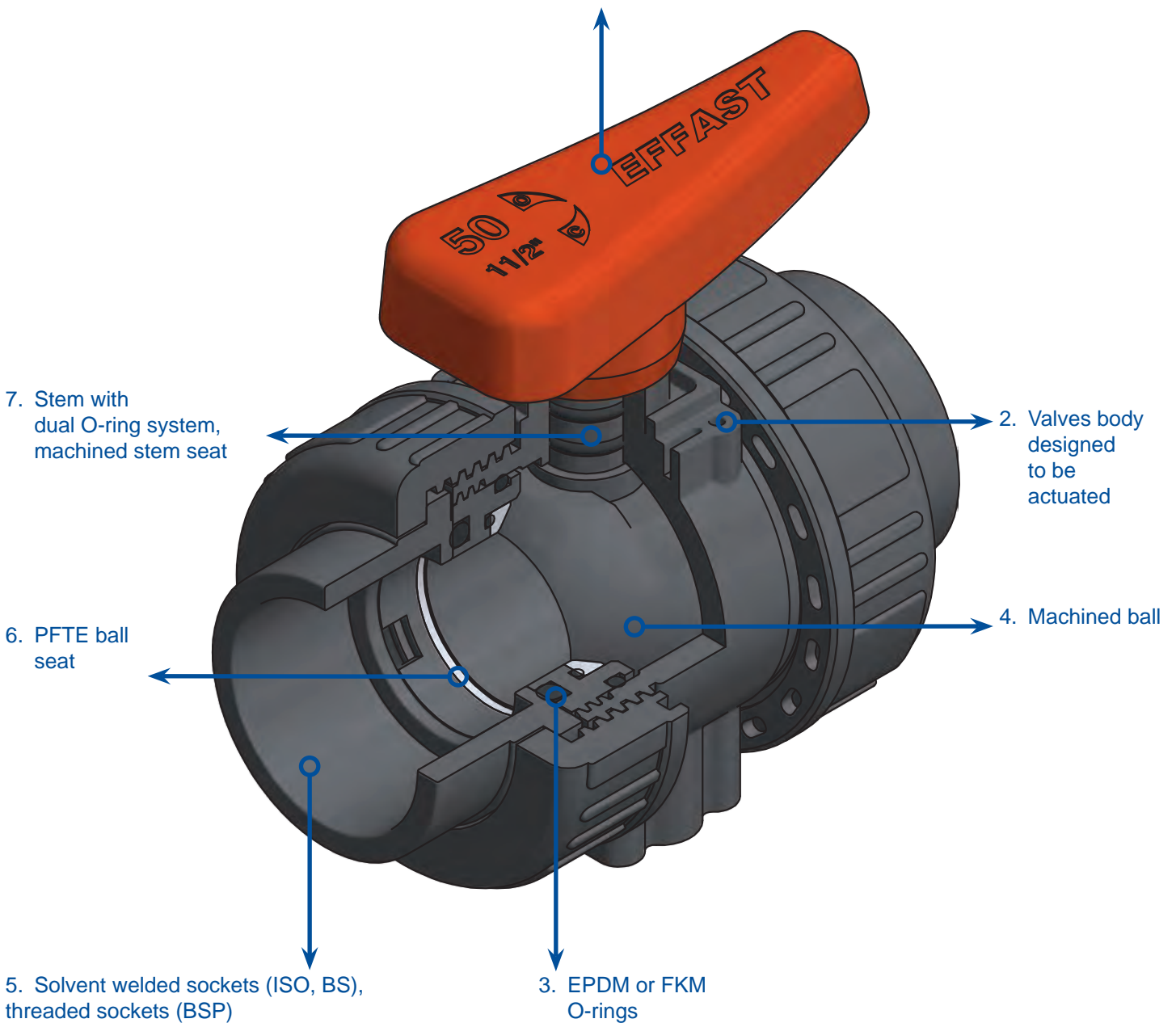

# PVC-u Industrial Manual Ball Valves Imperial

## PSPVV

**PVC-u Industrial Manual Ball Valves Imperial**  
Industrial Double Union Ball Valve Plain Sockets EPDM Seals

Nominal size (d)	Code	DN	L	C1	C2	H	Z	E	PN	Price each
3/8"	RBA22A0160	15	14.5	22	42	50	51	49	16	£53.49
1/2"	RBA22A0200	15	16	22	42	50	48	49	16	£53.96
3/4"	RBA22A0250	20	19	24	49	58	54	60	16	£65.74
1"	RBA22A0320	25	22	26	59	69	62	69	16	£78.38
1 1/4"	RBA22A0400	32	26	32	65	76	69	80	16	£100.58
1 1/2"	RBA22A0500	40	31	40	71	92	81	96	16	£128.71
2"	RBA22A0630	50	39	45	79	104	94	116	16	£180.47
2 1/2"	RBA22A0750	65	44	84.5	84.5	145	141	167	16	£395.52
3"	RBA22A0900	80	51	84.5	84.5	145	140	167	16	£507.38
4"	RBA22A1100	100	61	102	102	170	162	209	16	£707.08

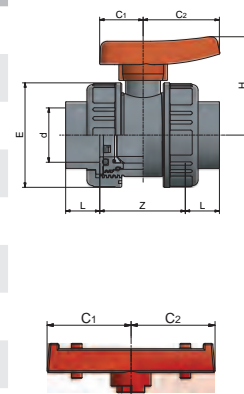

## PSPVV

**PVC-u Industrial Manual Ball Valves Imperial**  
Industrial Double Union Ball Valve Plain Sockets EPDM Seals Actuation Ready

Nominal size (d)	Code	DN	L	C1	C2	H1	H2	Z	E	K	Ø x h	PN	Price each
3/8"	RBA22A0160A	15	14.5	22	42	50	25	51	49	18	M4 x 8	16	£56.16
1/2"	RBA22A0200A	15	16	22	42	50	25	48	49	18	M4 x 8	16	£56.79
3/4"	RBA22A0250A	20	19	24	49	58	31	54	60	21.5	M4 x 8	16	£69.21
1"	RBA22A0320A	25	22	26	59	69	35	62	69	28	M4 x 8	16	£82.51
1 1/4"	RBA22A0400A	32	26	32	65	76	41	69	80	30	M5 x 10	16	£105.87
1 1/2"	RBA22A0500A	40	31	40	71	92	50	81	96	38	M6 x 14	16	£135.48
2"	RBA22A0630A	50	39	45	79	104	62	94	116	45	M6 x 14	16	£189.98
2 1/2"	RBA22A0750A	65	44	84.5	84.5	145	84	141	167	-	-	16	£416.35
3"	RBA22A0900A	80	51	84.5	84.5	145	84	140	167	-	-	16	£534.08
4"	RBA22A1100A	100	61	102	102	170	105	162	209	-	-	16	£744.30

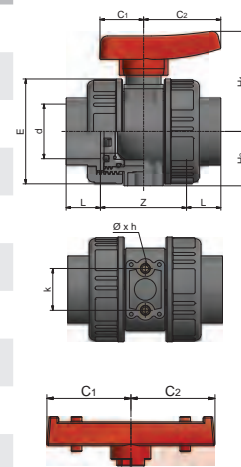

**PSPVV**
**PVC-u Industrial Manual Ball Valves Imperial**  
 Industrial Double Union Ball Valve Plain Sockets FKM Seals Actuation Ready

Nominal size (d)	Code	DN	L	C1	C2	H1	H2	Z	E	K	Ø x h	PN	Price each
3/8"	<b>RBA23A0160A</b>	15	14.5	22	42	50	25	51	49	18	M4 x 8	16	£72.94
1/2"	<b>RBA23A0200A</b>	15	16	22	42	50	25	48	49	18	M4 x 8	16	£74.00
3/4"	<b>RBA23A0250A</b>	20	19	24	49	58	31	54	60	21.5	M4 x 8	16	£88.67
1"	<b>RBA23A0320A</b>	25	22	26	59	69	35	62	69	28	M4 x 8	16	£107.65
1 1/4"	<b>RBA23A0400A</b>	32	26	32	65	76	41	69	80	30	M5 x 10	16	£113.78
1 1/2"	<b>RBA23A0500A</b>	40	31	40	71	92	50	81	96	38	M6 x 14	16	£176.67
2"	<b>RBA23A0630A</b>	50	39	45	79	104	62	94	116	45	M6 x 14	16	£247.52
2 1/2"	<b>RBA23A0750A</b>	65	44	84.5	84.5	145	84	141	167	-	-	16	£542.10
3"	<b>RBA23A0900A</b>	80	51	84.5	84.5	145	84	140	167	-	-	16	£681.57
4"	<b>RBA23A1100A</b>	100	61	102	102	170	105	162	209	-	-	16	£925.10

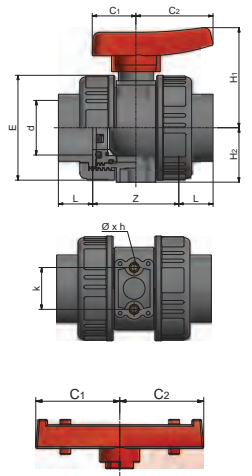

## PVC-u Industrial Manual Ball Valves Metric

**PSPVV**
**PVC-u Industrial Manual Ball Valves Metric**  
 Industrial Double Union Ball Valve Plain Sockets EPDM Seals

Nominal size (d)	Code	DN	L	C1	C2	H	Z	E	PN	Price each
16	<b>RBI22I0160</b>	15	14.5	22	42	50	51	49	16	£53.49
20	<b>RBI22I0200</b>	15	16	22	42	50	48	49	16	£53.96
25	<b>RBI22I0250</b>	20	19	24	49	58	54	60	16	£66.03
32	<b>RBI22I0320</b>	25	22	26	59	69	62	69	16	£78.38
40	<b>RBI22I0400</b>	32	26	32	65	76	69	80	16	£91.30
50	<b>RBI22I0500</b>	40	31	40	71	92	81	96	16	£101.34
63	<b>RBI22I0630</b>	50	39	45	79	104	94	116	16	£180.47
75	<b>RBI22I0750</b>	65	44	84.5	84.5	145	141	167	16	£395.52
90	<b>RBI22I0900</b>	80	51	84.5	84.5	145	140	167	16	£507.38
110	<b>RBI22I1100</b>	100	61	102	102	170	162	209	16	£707.08

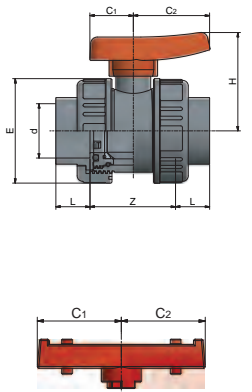

**PSPVV**

**PVC-u Industrial Manual Ball Valves Metric**  
Industrial Double Union Ball Valve Plain Sockets EPDM Seals Actuation Ready

Nominal size (d)	Code	DN	L	C1	C2	H1	H2	Z	E	K	Ø x h	PN	Price each
16	<b>RBI22I0160A</b>	15	14.5	22	42	50	25	51	49	18	M4 x 8	16	£56.16
20	<b>RBI22I0200A</b>	15	16	22	42	50	25	48	49	18	M4 x 8	16	£56.79
25	<b>RBI22I0250A</b>	20	19	24	49	58	31	54	60	21.5	M4 x 8	16	£69.51
32	<b>RBI22I0320A</b>	25	22	26	59	69	35	62	69	28	M4 x 8	16	£82.51
40	<b>RBI22I0400A</b>	32	26	32	65	76	41	69	80	30	M5 x 10	16	£96.11
50	<b>RBI22I0500A</b>	40	31	40	71	92	50	81	96	38	M6 x 14	16	£106.67
63	<b>RBI22I0630A</b>	50	39	45	79	104	62	94	116	45	M6 x 14	16	£189.98
75	<b>RBI22I0750A</b>	65	44	84.5	84.5	145	84	141	167	-	-	16	£416.35
90	<b>RBI22I0900A</b>	80	51	84.5	84.5	145	84	140	167	-	-	16	£534.08
110	<b>RBI22I1100A</b>	100	61	102	102	170	105	162	209	-	-	16	£744.30

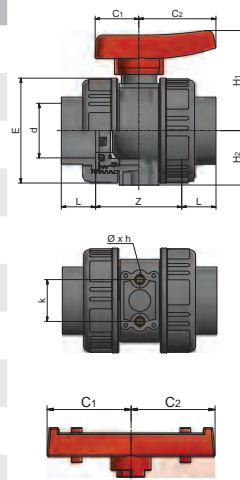

**PSPVV**

**PVC-u Industrial Manual Ball Valves Metric**  
Industrial Double Union Ball Valve Plain Sockets FKM Seals Actuation Ready

Nominal size (d)	Code	DN	L	C1	C2	H1	H2	Z	E	K	Ø x h	PN	Price each
16	<b>RBI23I0160A</b>	15	14.5	22	42	50	25	51	49	18	M4 x 8	16	£72.94
20	<b>RBI23I0200A</b>	15	16	22	42	50	25	48	49	18	M4 x 8	16	£74.00
25	<b>RBI23I0250A</b>	20	19	24	49	58	31	54	60	21.5	M4 x 8	16	£88.67
32	<b>RBI23I0320A</b>	25	22	26	59	69	35	62	69	28	M4 x 8	16	£108.08
40	<b>RBI23I0400A</b>	32	26	32	65	76	41	69	80	30	M5 x 10	16	£138.57
50	<b>RBI23I0500A</b>	40	31	40	71	92	50	81	96	38	M6 x 14	16	£176.13
63	<b>RBI23I0630A</b>	50	39	45	79	104	62	94	116	45	M6 x 14	16	£219.66
75	<b>RBI23I0750A</b>	65	44	84.5	84.5	145	84	141	167	-	-	16	£542.10
90	<b>RBI23I0900A</b>	80	51	84.5	84.5	145	84	140	167	-	-	16	£637.58
110	<b>RBI23I1100A</b>	100	61	102	102	170	105	162	209	-	-	16	£893.43

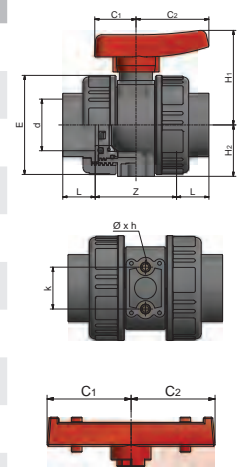

# PVC-u Industrial Manual Ball Valves Threaded Imperial

**PSPVV**

**PVC-u Industrial Manual Ball Valves Threaded Imperial**  
Industrial Double Union Ball Valve BSP Female Threaded Sockets EPDM Seals

Nominal Size (Rp)	Code	DN	L min	C1	C2	H	Z max	E	PN	Price each
3/8"	RBF22F0160	15	10.1	22	42	50	59.8	49	16	£55.58
1/2"	RBF22F0200	15	13.2	22	42	50	53.6	49	16	£64.73
3/4"	RBF22F0250	20	14.5	24	49	58	63	60	16	£78.05
1"	RBF22F0320	25	16.8	26	59	69	72.4	69	16	£87.01
1 1/4"	RBF22F0400	32	19.1	32	65	76	82.8	80	16	£112.75
1 1/2"	RBF22F0500	40	19.1	40	71	92	91.8	96	16	£142.77
2"	RBF22F0630	50	23.4	45	79	104	103.2	116	16	£215.09
2 1/2"	RBF22F0750	65	26.7	84.5	84.5	145	175.6	167	16	£416.35
3"	RBF22F0900	80	29.8	84.5	84.5	145	153.4	167	16	£484.49
4"	RBF22F1100	100	61	102	102	170	162	209	16	£696.27

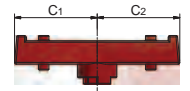
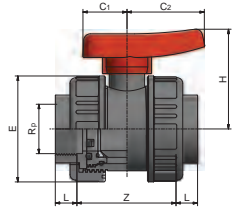

**PSPVV**

**PVC-u Industrial Manual Ball Valves Threaded Imperial**  
Industrial Double Union Ball Valve BSP Female Threaded Sockets EPDM Seals Actuation Ready

Nominal Size (Rp)	Code	DN	L min	C1	C2	H1	H2	Z max	E	K	Ø x h	PN	Price each
3/8"	RBF22F0160A	15	11.4	22	42	50	25	49	49	18	M4 x 8	16	£58.35
1/2"	RBF22F0200A	15	15	22	42	50	25	49	49	18	M4 x 8	16	£67.97
3/4"	RBF22F0250A	20	16.3	24	49	58	31	60	60	21.5	M4 x 8	16	£81.95
1"	RBF22F0320A	25	19.5	26	59	69	35	69	69	28	M4 x 8	16	£91.60
1 1/4"	RBF22F0400A	32	21.4	32	65	76	41	80	80	30	M5 x 10	16	£118.68
1 1/2"	RBF22F0500A	40	21.4	40	71	92	50	96	96	38	M6 x 14	16	£150.29
2"	RBF22F0630A	50	25.7	45	79	104	62	116	116	45	M6 x 14	16	£225.84
2 1/2"	RBF22F0750A	65	30.2	84.5	84.5	145	84	167	167	-	-	16	£437.17
3"	RBF22F0900A	80	33.3	84.5	84.5	145	84	167	167	-	-	16	£508.71
4"	RBF22F1100A	100	39.3	102	102	170	105	209	209	-	-	16	£731.08

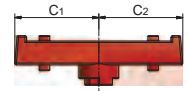
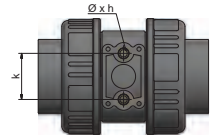
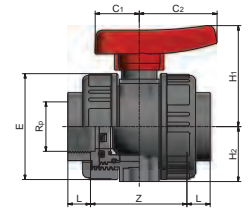

PVC-u - Valves

**PSPVV**

**PVC-u Industrial Manual Ball Valves Threaded Imperial**

Industrial Double Union Ball Valve BSP Female Threaded Sockets FKM Seals Actuation Ready

Nominal Size (Rp)	Code	DN	L min	C1	C2	H1	H2	Z max	E	K	Ø x h	PN	Price each
3/8"	<b>RBFB23F0160A</b>	15	11.4	22	42	50	25	57.2	49	18	M4 x 8	16	£72.94
1/2"	<b>RBFB23F0200A</b>	15	15	22	42	50	25	50	49	18	M4 x 8	16	£83.16
3/4"	<b>RBFB23F0250A</b>	20	16.3	24	49	58	31	59.4	60	21.5	M4 x 8	16	£95.89
1"	<b>RBFB23F0320A</b>	25	19.5	26	59	69	35	67	69	28	M4 x 8	16	£128.05
1 1/4"	<b>RBFB23F0400A</b>	32	21.4	32	65	76	41	78.2	80	30	M5 x 10	16	£158.73
1 1/2"	<b>RBFB23F0500A</b>	40	21.4	40	71	92	50	87.2	96	38	M6 x 14	16	£193.65
2"	<b>RBFB23F0630A</b>	50	25.7	45	79	104	62	98.6	116	45	M6 x 14	16	£239.40
2 1/2"	<b>RBFB23F0750A</b>	65	30.2	84.5	84.5	145	84	168.6	167	-	-	16	£542.10
3"	<b>RBFB23F0900A</b>	80	33.3	84.5	84.5	145	84	146.4	167	-	-	16	£681.56
4"	<b>RBFB23F1100A</b>	100	39.3	102	102	170	105	205.4	209	-	-	16	£709.03

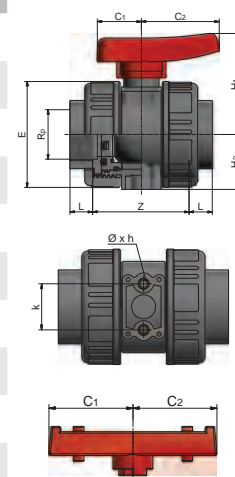

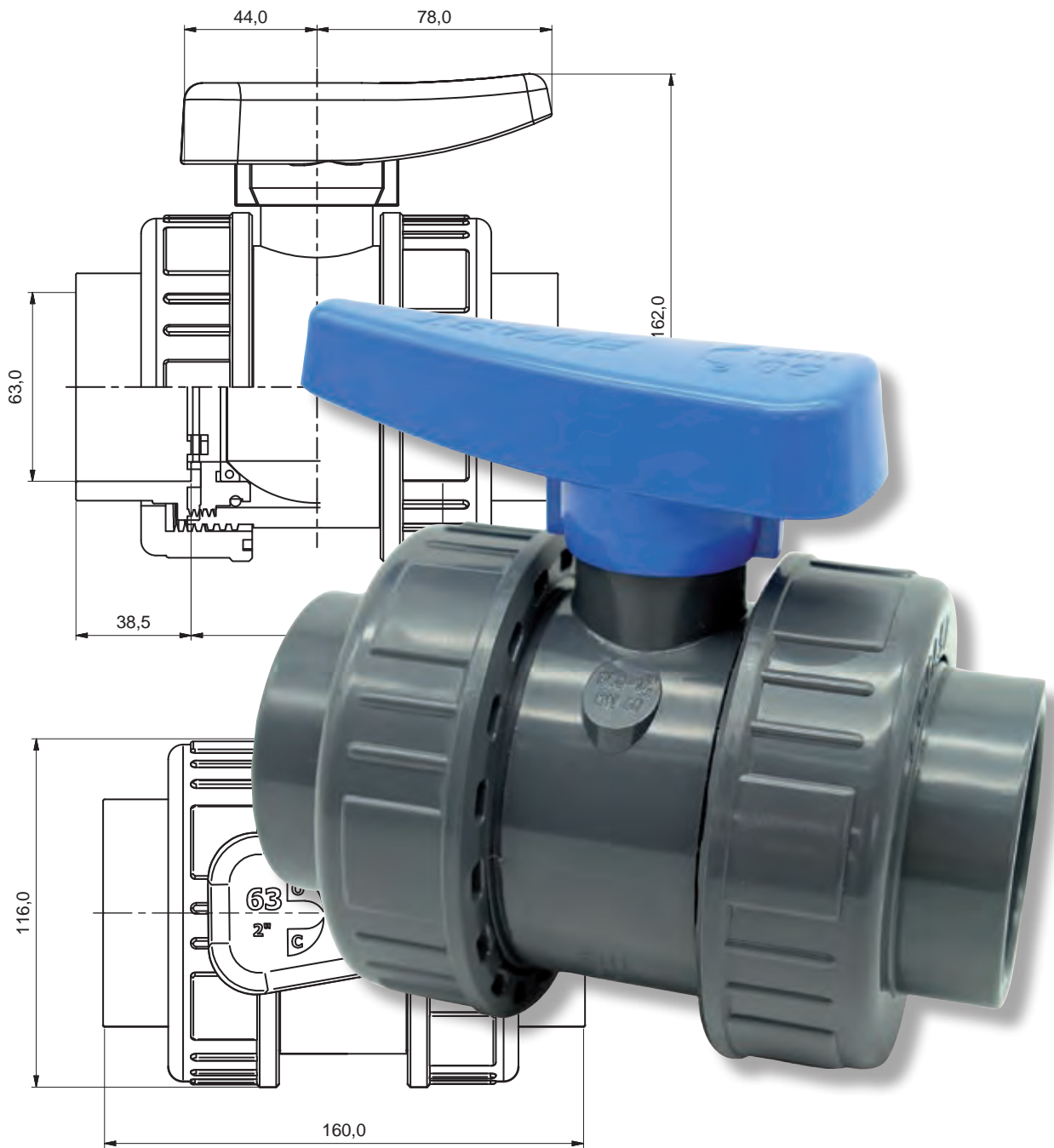

# PVC-u Water Supply Manual Ball Valves



## Technical Features

- Floating full bore ball locked in place on both sides
- Fully round ball smoothed by special turning machine
- Solvent welded sockets or threaded sockets
- PE ball seat
- Nominal pressure (PN): 16 bar – 232 psi at 20°C
- Handle with combined key for the dismantling of the valve and the tightening of threaded gasket carrier
- The valves are manufactured with a PVC-u fit for contact with potable water in accordance with regulations in U.K., Italy, France, Germany, Holland and Scandinavian countries.

## Torque: PVC-u Ball Valve

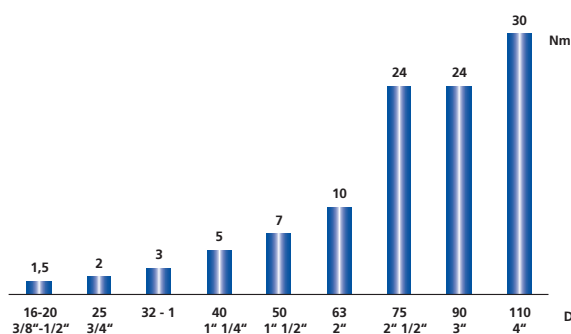

## Pressure Loss: PVC-u Ball Valves

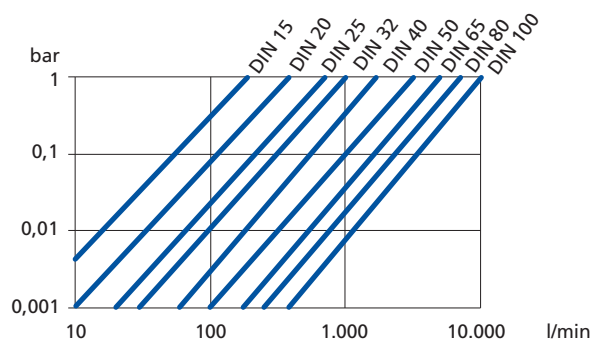

## Maximum Working Pressure: PVC-u Ball Valves

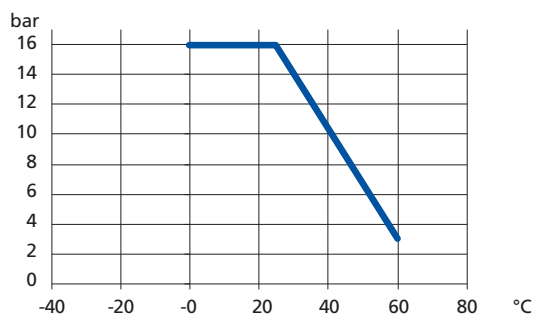

## Flow Rate: PVC-u Ball Valves

d	16/20	25	32	40	50	63	75	90	110
DN	15	20	25	32	40	50	65	80	100
L/m $\Delta P = 1$ Bar	190	380	700	1000	1700	3200	5000	7000	10000

## PVC-u Water Supply Manual Ball Valves

Marine approval  
CE Approval



1. Ergonomic handle with integrated tool for removing of union bushings and adjust the ball seat carrier

2. Threaded gasket carrier

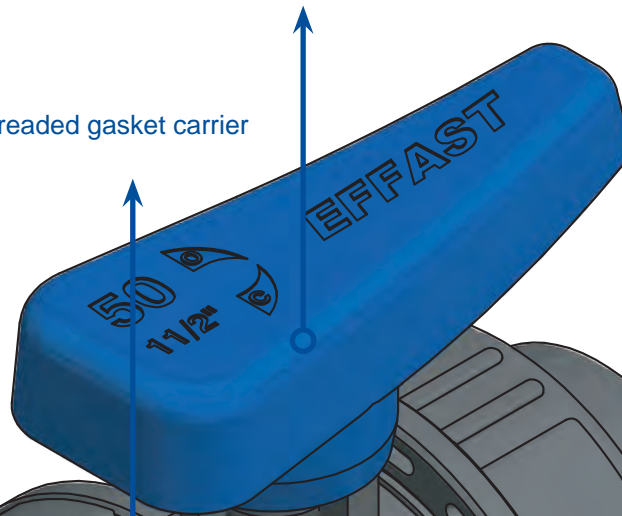

3. Stem with dual O-ring system

4. Solvent welded sockets (ISO, BS, ASTM, JIS) or threaded sockets (BSP)

7. Machined ball

6. EPDM Seals

5. PE ball seat

# PVC-u Water Supply Manual Ball Valves

## PSPVV

**PVC-u Water Supply Manual Ball Valves Imperial**  
Water Supply Double Union Ball Valve Plain Sockets EPDM Seals

Nominal size (d)	Code	L	C1	C2	Z	H	E	PN	Price each
3/8"	RBA21A0160	14.5	22	42	51	50	49	16	£20.02
1/2"	RBA21A0200	16	22	42	48	50	49	16	£21.69
3/4"	RBA21A0250	19	24	49	54	58	60	16	£25.50
1"	RBA21A0320	22	26	59	62	69	69	16	£30.65
1 1/4"	RBA21A0400	26	32	65	69	76	80	16	£39.27
1 1/2"	RBA21A0500	31	40	71	81	92	96	16	£45.32
2"	RBA21A0630	39	45	79	94	104	116	16	£83.07
2 1/2"	RBA21A0750	44	84.5	84.5	141	145	167	16	£262.64
3"	RBA21A0900	51	84.5	84.5	140	145	167	16	£343.78
4"	RBA21A1100	61	102	102	162	170	209	16	£451.96

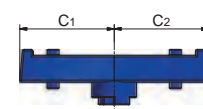
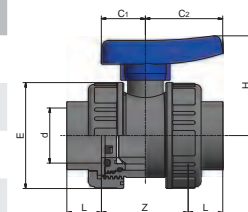

## PSPVV

**PVC-u Water Supply Manual Ball Valves Metric**  
Water Supply Double Union Ball Valve Plain Sockets EPDM Seals

Nominal size (d)	Code	L	C1	C2	Z	H	E	PN	Price each
16	RBI21I0160	14.5	22	42	51	50	49	16	£20.02
20	RBI21I0200	16	22	42	48	50	49	16	£21.69
25	RBI21I0250	19	24	49	54	58	60	16	£25.50
32	RBI21I0320	22	26	59	62	69	69	16	£30.65
40	RBI21I0400	26	32	65	69	76	80	16	£39.27
50	RBI21I0500	31	40	71	81	92	96	16	£45.32
63	RBI21I0630	39	45	79	94	104	116	16	£83.07
75	RBI21I0750	44	84.5	84.5	141	145	167	16	£262.64
90	RBI21I0900	51	84.5	84.5	140	145	167	16	£343.78
110	RBI21I1100	61	102	102	162	170	209	16	£451.96

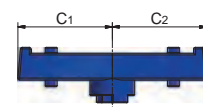
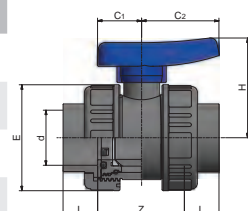

**PSPVV**
**PVC-u Water Supply Manual Ball Valves Threaded Imperial**  
 Double Union Ball Valve BSP Female Threaded Sockets EPDM Seals

Nominal size (Rp)	Code	L Min	C1	C2	Z Max	H	E	PN	Price each
3/8"	<b>RBF21F0160</b>	10.1	22	42	59.8	50	49	16	£18.82
1/2"	<b>RBF21F0200</b>	13.2	22	42	53.6	50	49	16	£21.57
3/4"	<b>RBF21F0250</b>	14.5	24	49	63	58	60	16	£23.13
1"	<b>RBF21F0320</b>	16.8	26	59	72.4	69	69	16	£33.66
1 1/4"	<b>RBF21F0400</b>	19.1	32	65	82.8	76	80	16	£42.08
1 1/2"	<b>RBF21F0500</b>	19.1	40	71	91.8	92	96	16	£49.50
2"	<b>RBF21F0630</b>	23.4	45	79	103.2	109	116	16	£87.75
2 1/2"	<b>RBF21F0750</b>	26.7	84.5	84.5	175.6	145	167	16	£269.48
3"	<b>RBF21F0900</b>	29.8	84.5	84.5	153.4	145	167	16	£358.40
4"	<b>RBF21F1100</b>	61	102	102	157	170	179	16	£472.41

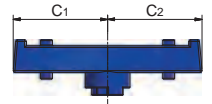
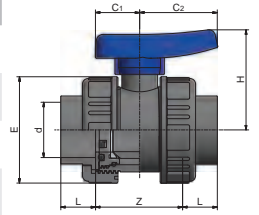

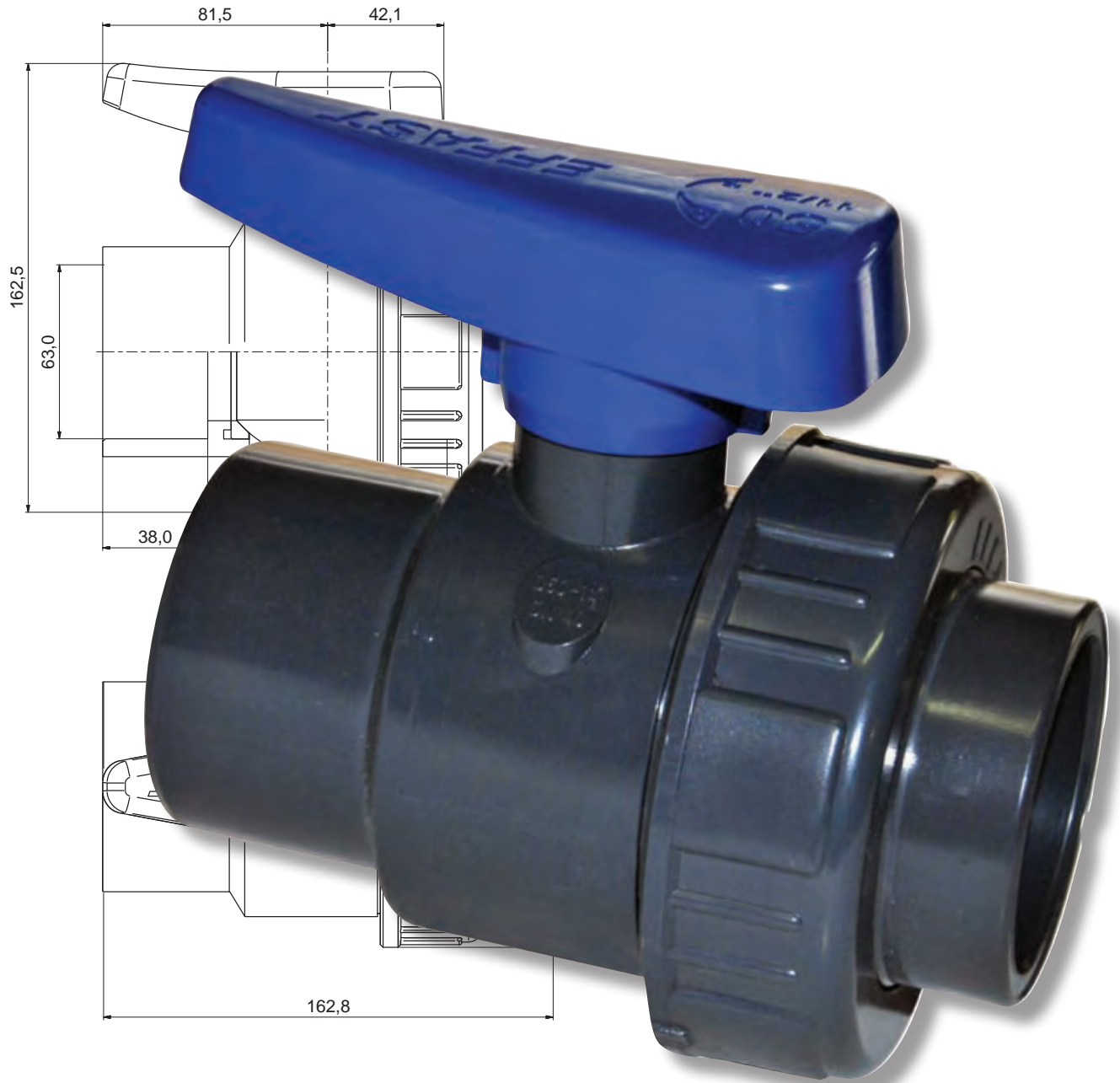

## PVC-u Water Supply Single Union Manual Ball Valves

## PVC-u Water Supply Single Union Manual Ball Valves

Marine approval  
CE Approval



1. Ergonomic handle with integrated tool for removing of union bushings and adjust the ball seat carrier

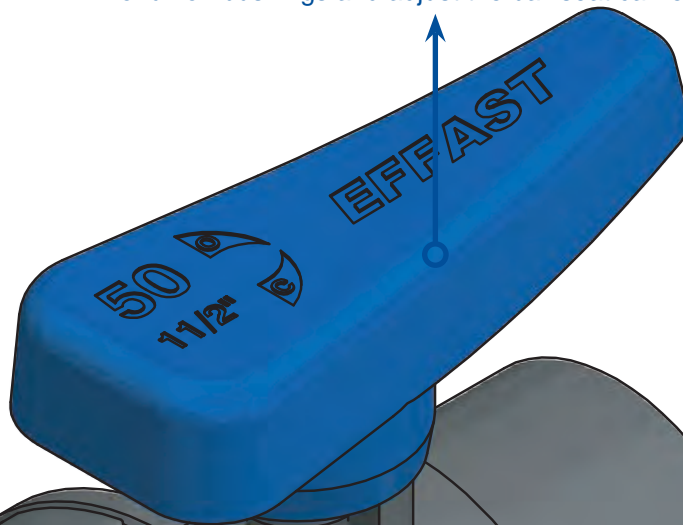

2. Stem with dual O-ring system

3. PE ball seat

4. Solvent welded sockets (ISO, BS) threaded sockets (BSP)

7. Threaded ball seat carrier

6. Machined ball

5. EPDM Seals

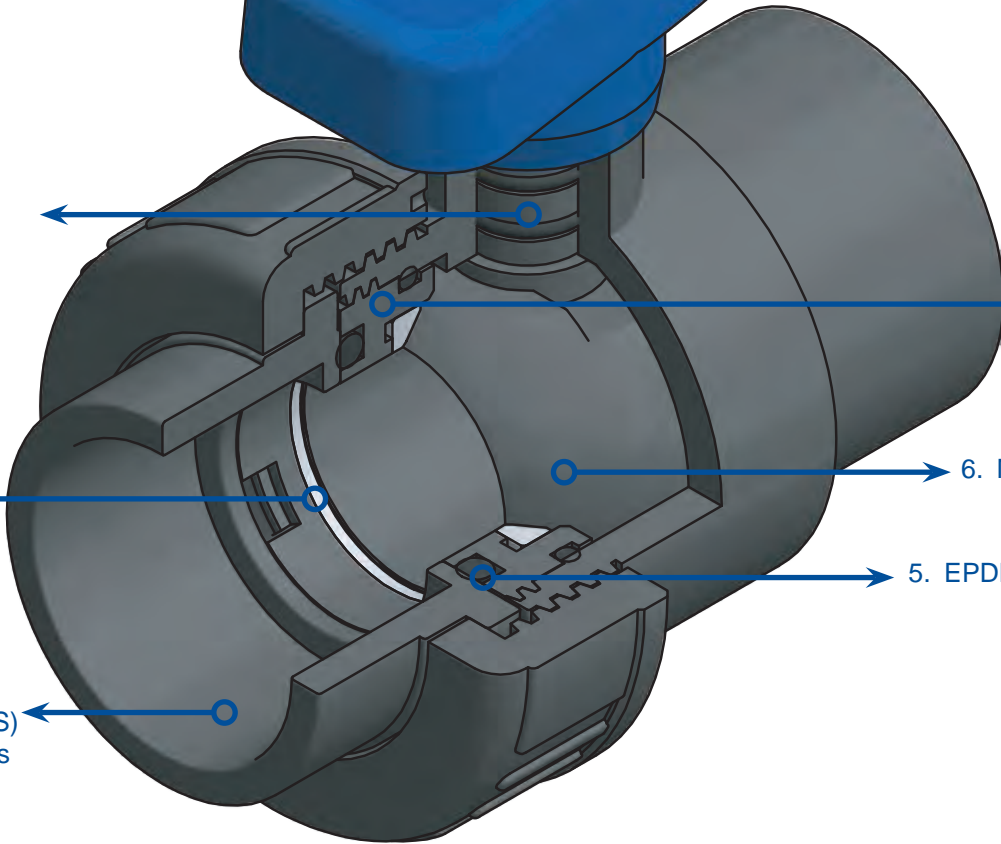

# PVC-u Water Supply Single Union Manual Ball Valves

## Technical Features

- Floating full bore ball
- Fully round ball smoothed by special turning machine
- Solvent welded sockets, threaded sockets or compression joints
- PE ball seat
- Nominal pressure (PN): 16 bar – 232 psi at 20°C
- Handle with combined key for the dismantling of the valve and the tightening of threaded gasket carrier
- The valves are manufactured with a PVC-u fit for contact with potable water in accordance with regulations in U.K., Italy, France, Germany, Holland and Scandinavian countries.

## Torque: PVC-u Ball Valves

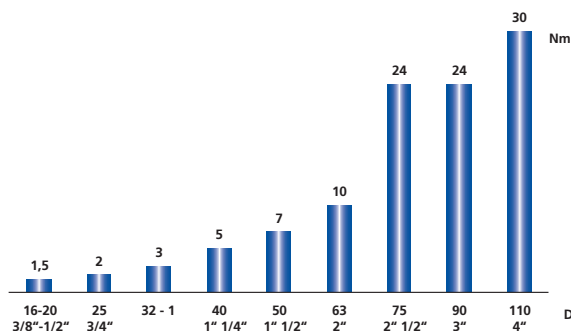

## Pressure Loss: PVC-u Ball Valves

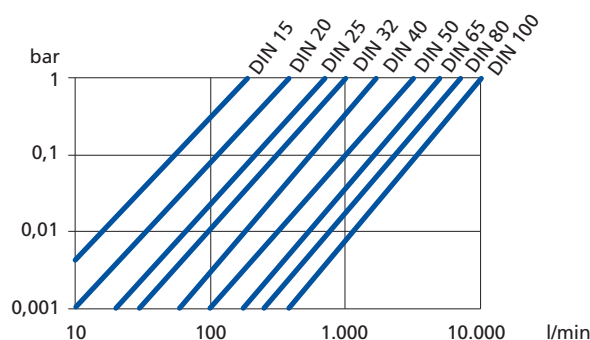

## Maximum Working Pressure: PVC-u Ball Valves

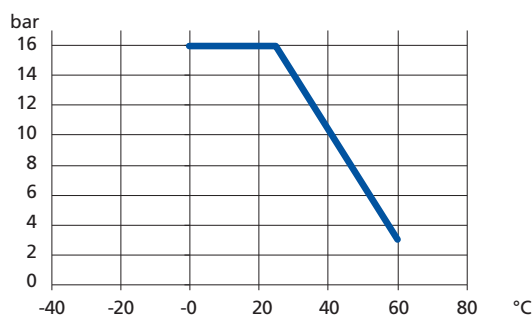

## Flow Rate: PVC-u Ball Valves

d	16/20	25	32	40	50	63	75	90	110
DN	15	20	25	32	40	50	65	80	100
L/m ΔP =1 Bar	190	380	700	1000	1700	3200	5000	7000	10000

# PVC-u Water Supply Single Union Manual Ball Valves

**PSPVV**
**PVC-u Water Supply Single Union Manual Ball Valves Imperial**  
 Water Supply Single Union Ball Valve Plain Sockets EPDM Seals

Nominal size (d)	Code	DN	L	C1	C2	Z	H	E	PN	Price each
3/8"	RBA11A0160	15	14.5	22	42	44	50	49	16	£11.88
1/2"	RBA11A0200	15	16	22	42	41	50	49	16	£15.86
3/4"	RBA11A0250	20	19	24	49	48	58	60	16	£18.14
1"	RBA11A0320	25	22	26	59	54	69	69	16	£21.36
1 1/4"	RBA11A0400	32	26	32	65	62	76	80	16	£28.16
1 1/2"	RBA11A0500	40	31	40	71	72	92	96	16	£41.87
2"	RBA11A0630	50	39	45	79	86.5	104	116	16	£72.94
2 1/2"	RBA11A0750	65	44	84.5	84.5	132.5	145	167	16	£157.15
3"	RBA11A0900	80	51	84.5	84.5	125	145	167	16	£181.87
4"	RBA11A1100	100	61	102	102	158	170	209	16	£321.37

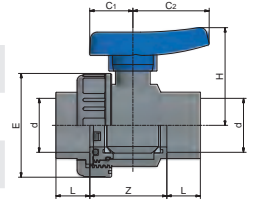
**PSPVV**
**PVC-u Water Supply Single Union Manual Ball Valves Metric**  
 Water Supply Single Union Ball Valve Plain Sockets EPDM Seals

Nominal size (d)	Code	DN	L	C1	C2	Z	H	E	PN	Price each
16	RBI11I0160	15	14.5	22	42	44	50	49	16	£15.00
20	RBI11I0200	15	16	22	42	41	50	49	16	£15.00
25	RBI11I0250	20	19	24	49	48	58	60	16	£16.17
32	RBI11I0320	25	22	26	59	54	69	69	16	£17.60
40	RBI11I0400	32	26	32	65	62	76	80	16	£27.41
50	RBI11I0500	40	31	40	71	72	92	96	16	£37.41
63	RBI11I0630	50	39	45	79	86.5	104	116	16	£70.86
75	RBI11I0750	65	44	84.5	84.5	132.5	145	167	16	£152.54
90	RBI11I0900	80	51	84.5	84.5	125	145	167	16	£176.67
110	RBI11I1100	100	61	102	102	158	170	209	16	£312.02

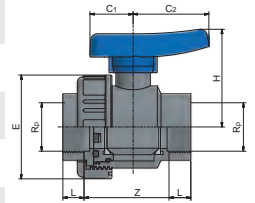



**PSPVV**

**PVC-u Water Supply Single Union Manual Ball Valves Threaded Imperial**  
Water Supply Single Union Ball Valve BSP Female Threaded EPDM Seals

Nominal size (d)	Code	L Min	C1	C2	Z Max	H	E	PN	Price each
3/8"	<b>RBF11F0160</b>	10.1	22	42	52.8	50	49	16	£16.98
1/2"	<b>RBF11F0200</b>	13.2	22	42	46.6	50	49	16	£16.98
3/4"	<b>RBF11F0250</b>	14.5	24	49	57	58	60	16	£19.07
1"	<b>RBF11F0320</b>	16.8	26	59	64.4	69	69	16	£23.77
1 1/4"	<b>RBF11F0400</b>	19.1	32	65	55.8	76	80	16	£30.32
1 1/2"	<b>RBF11F0500</b>	19.1	40	71	95.8	92	96	16	£44.52
2"	<b>RBF11F0630</b>	23.4	45	79	117.7	104	116	16	£74.80
2 1/2"	<b>RBF11F0750</b>	26.7	84.5	84.5	167.1	145	167	16	£176.85
3"	<b>RBF11F0900</b>	29.8	84.5	84.5	167.4	145	167	16	£216.14
4"	<b>RBF11F1100</b>	61	102	102	158	170	209	16	£337.45

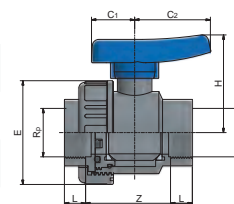

# PVC-u 3 Way Industrial Manual Ball Valves Imperial

**PSAQU**

**PVC-u 3 Way Industrial Manual Ball Valves Imperial**  
3 Way Ball Valve T Port Plain BS E Plain Ends EPDM Seals

Nominal size	Code	D	Price each
¾"	<b>RBA82T0250</b>	¾"	£145.50
1"	<b>RBA82T0320</b>	1"	£145.50
1½"	<b>RBA82T0500</b>	1½"	£221.61
2"	<b>RBA82T0630</b>	2"	£290.13



**PSAQU**

**PVC-u 3 Way Industrial Manual Ball Valves Imperial**  
3 Way Ball Valve L Port Plain BS EPDM O Rings Plain Ends

Nominal size	Code	D	Price each
¾"	<b>RBA83L0250</b>	¾"	£135.92
1"	<b>RBA83L0320</b>	1"	£135.92
2"	<b>RBA83L0630</b>	2"	£262.00



PVC-u - Valves

# PVC-u 3 Way Industrial Manual Ball Valves Metric

**PSAQU**

**PVC-u 3 Way Industrial Manual Ball Valves Metric**  
3 Way Ball Valve T Port EPDM O Rings Plain Ends

Nominal Size (d)	Code	DN	L	Z	A	C	H1	H2	E	PN	Price each
25	<b>RBI81T0250</b>	20	20	126	120	51.5	60	63	70	16	£145.50
32	<b>RBI81T0320</b>	25	22.5	126	120	51.5	60	63	70	16	£145.50
50	<b>RBI81T0500</b>	40	31.5	171	162	73	81	85.5	101	16	£221.61
63	<b>RBI81T0630</b>	50	38.5	192	181	85	90.5	96	124.5	16	£290.13

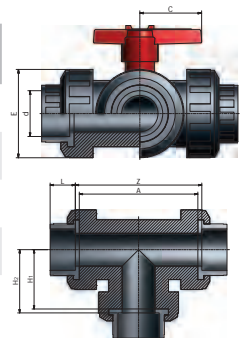

**PSAQU**

**PVC-u 3 Way Industrial Manual Ball Valves Metric**  
3 Way Ball Valve L Port EPDM O Rings Plain Ends

Nominal Size (d)	Code	L	Z	A	C	H1	H2	E	PN	Price each
25	<b>RBI80L0250</b>	20	126	120	51.5	60	63	70	16	£135.92
32	<b>RBI80L0320</b>	22.5	126	120	51.5	60	63	70	16	£135.92
50	<b>RBI80L0500</b>	31.5	171	162	73	81	85.5	101	16	£210.39
63	<b>RBI80L0630</b>	38.5	192	181	85	90.5	96	124.5	16	£262.00

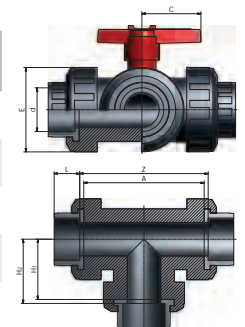

# PVC-U Double union check valves

New EFFAST check valve: new spring check valve, ideal for use in applications that require precise closure and noiseless movement, and ball check valve, without metal parts to be used with corrosive fluids and suitable as foot valve. Suitable for use in water treatment, SPAs and pools.



## Ball Check Valve CB

- Suitable for vertical installation
- PVC-U high surface finish machined ball
- EDPM or FKM seals available
- No metal parts in contact with the fluid
- Also suitable to be used as a foot valve

## Spring Check Valve

- Suitable for vertical and horizontal installation
- Stainless Steel Spring: PTFE coated spring available on request
- EDPM or FKM seals available
- Transparent PVC Body available, for easier inspection of the plant
- Marine Application Certificate

# PVC-u Check Valves

## Spring Check Valve

## Ball Check Valve CB



1. Spring, ideal for horizontal installation. Silent closure and **perfect seal, even with low back pressure** and in case of strong vibrations.
2. **Safe and controlled movement**, thanks to the guides on plunger.
3. **Shaped gasket** for a secure seal even at low temperatures.
4. **Smooth finished Ball and self-cleaning internal valve**. Ideal for conveying dirty fluids.

Technical features	
Nominal pressure	PN 16 (20°C)
Dimensions	DN 15 - DN 50 (d. 16 - 63 mm - 1/2" - 2")
Valve material	PVC-U
Seals material	O-rings: EPDM or FKM
Temperature range	0°C - 60°C
Coupling standards	Solvent welded sockets: Metric, BS Threaded sockets: BSPP

# PVC-u Check Valves Imperial

## PSPVV

### PVC-u Check Valves Imperial

Check Valve Plain Sockets with Stainless Steel Spring EPDM Seals

Nominal size (d)	Code	DN	L	Z	E	PN	Price each
3/8"	RBA30A0160	15	14.5	51	49	16	£43.67
1/2"	RBA30A0200	15	16	48	49	16	£53.31
3/4"	RBA30A0250	20	19	54	60	16	£54.63
1"	RBA30A0320	25	22	62	69	16	£56.37
1 1/4"	RBA30A0400	32	26	69	80	16	£66.17
1 1/2"	RBA30A0500	40	31	81	96	16	£96.29
2"	RBA30A0630	50	39	94	116	16	£127.34
2 1/2"	RBA30A0750	65	44	141	167	16	£300.04
3"	RBA30A0900	80	51	140	167	16	£387.46
4"	RBA30A1100	100	61	157	179	10	£754.79

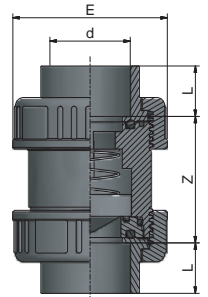

## PSPVV

### PVC-u Check Valves Imperial

Check Valve Plain Sockets with Ball EPDM Seals

Nominal size (d)	Code	DN	L	Z	E	PN	Price each
1/2"	CARCBA0200	15	16	48	49	16	£55.97
3/4"	CARCBA0250	20	19	54	60	16	£57.36
1"	CARCBA0320	25	22	62	69	16	£59.19
1 1/4"	CARCBA0400	32	26	69	80	16	£69.48
1 1/2"	CARCBA0500	40	31	81	96	16	£101.10
2"	CARCBA0630	50	39	94	116	16	£133.72

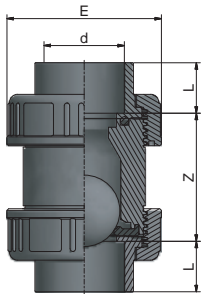

## PSPVV

### PVC-u Check Valves Imperial

Check Valve Plain Sockets with Ball FKM Seals

Nominal size (d)	Code	DN	L	Z	E	PN	Price each
1/2"	CARCBA020V	15	16	48	49	16	£67.16
3/4"	CARCBA025V	20	19	54	60	16	£68.84
1"	CARCBA032V	25	22	62	69	16	£71.02
1 1/4"	CARCBA040V	32	26	69	80	16	£83.37
1 1/2"	CARCBA050V	40	31	81	96	16	£121.32
2"	CARCBA063V	50	39	94	116	16	£160.46

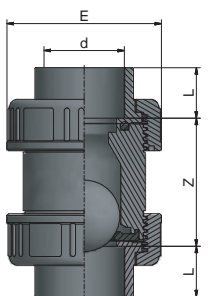

**PSPVV**
**PVC-u Check Valves Imperial**

Check Valve Plain Sockets with PTFE Coated Spring EPDM Seals

Nominal size (d)	Code	DN	L	Z	E	PN	Price each
½"	<b>RBA31A0200</b>	15	16	48	49	16	£71.49
¾"	<b>RBA31A0250</b>	20	19	54	60	16	£80.04
1"	<b>RBA31A0320</b>	25	22	62	69	16	£83.58
1¼"	<b>RBA31A0400</b>	32	26	69	80	16	£97.44
1½"	<b>RBA31A0500</b>	40	31	81	96	16	£127.34
2"	<b>RBA31A0630</b>	50	39	94	116	16	£162.88
2½"	<b>RBA31A0750</b>	65	44	141	167	16	£338.99
3"	<b>RBA31A0900</b>	80	51	140	167	16	£426.43

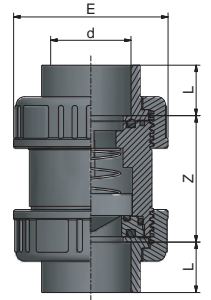
**PSPVV**
**PVC-u Check Valves Imperial**

Check Valve Plain Sockets with PTFE Coated Spring FKM Seals

Nominal size (d)	Code	DN	L	Z	E	PN	Price each
½"	<b>RBA34A0200</b>	15	16	48	49	16	£89.20
¾"	<b>RBA34A0250</b>	20	19	54	60	16	£98.70
1"	<b>RBA34A0320</b>	25	22	62	69	16	£104.62
1¼"	<b>RBA34A0400</b>	32	26	69	80	16	£121.73
1½"	<b>RBA34A0500</b>	40	31	81	96	16	£124.95
2"	<b>RBA34A0630</b>	50	39	94	116	16	£201.65
2½"	<b>RBA34A0750</b>	65	44	141	167	16	£504.18

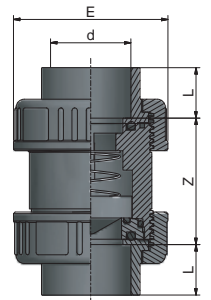

# PVC-u Check Valves Metric

## PSPVV

### PVC-u Check Valves Metric

Check Valve Plain Sockets with Stainless Steel Spring EPDM Seals

Nominal size (d)	Code	DN	L	Z	E	PN	Price each
16	RBI30I0160	15	14.5	51	49	16	£52.77
20	RBI30I0200	15	16	48	49	16	£54.74
25	RBI30I0250	20	19	54	60	16	£56.13
32	RBI30I0320	25	22	62	69	16	£59.04
40	RBI30I0400	32	26	69	80	16	£66.17
50	RBI30I0500	40	31	81	96	16	£96.29
63	RBI30I0630	50	39	94	116	16	£127.34
75	RBI30I0750	65	44	141	167	16	£300.04
90	RBI30I0900	80	51	140	167	16	£387.46
110	RBI30I1100	100	61	157	179	10	£754.52

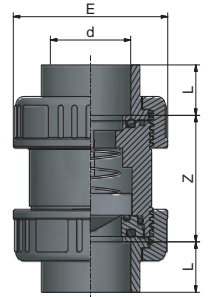

## PSPVV

### PVC-u Check Valves Imperial

Check Valve Plain Sockets with Ball EPDM Seals

Nominal size (d)	Code	DN	L	Z	E	PN	Price each
20	CDRCBD0200	15	16	48	49	16	£57.47
25	CDRCBD0250	20	19	54	60	16	£58.94
32	CDRCBD0320	25	22	62	69	16	£61.99
40	CDRCBD0400	32	26	69	80	16	£69.48
50	CDRCBD0500	40	31	81	96	16	£101.10
63	CDRCBD0630	50	39	94	116	16	£133.72

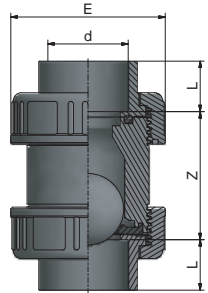

## PSPVV

### PVC-u Check Valves Imperial

Check Valve Plain Sockets with Ball FKM Seals

Nominal size (d)	Code	DN	L	Z	E	PN	Price each
20	CDRCBD020V	15	16	48	49	16	£68.96
25	CDRCBD025V	20	19	54	60	16	£70.73
32	CDRCBD032V	25	22	62	69	16	£74.39
40	CDRCBD040V	32	26	69	80	16	£83.37
50	CDRCBD050V	40	31	81	96	16	£121.32
63	CDRCBD063V	50	39	94	116	16	£160.46

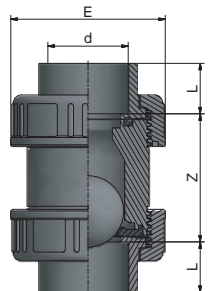



**PSPVV**
**PVC-u Check Valves Metric**

Check Valve Plain Sockets with PTFE Coated Spring EPDM Seals

Nominal size (d)	Code	DN	L	Z	E	PN	Price each
16	<b>RBI31I0160</b>	15	14.5	51	49	16	£71.49
20	<b>RBI31I0200</b>	15	16	48	49	16	£71.49
25	<b>RBI31I0250</b>	20	19	54	60	16	£80.04
32	<b>RBI31I0320</b>	25	22	62	69	16	£73.59
40	<b>RBI31I0400</b>	32	26	69	80	16	£97.44
50	<b>RBI31I0500</b>	40	31	81	96	16	£127.34
63	<b>RBI31I0630</b>	50	39	94	116	16	£162.88
75	<b>RBI31I0750</b>	65	44	141	167	16	£338.99
90	<b>RBI31I0900</b>	80	51	140	167	16	£426.43

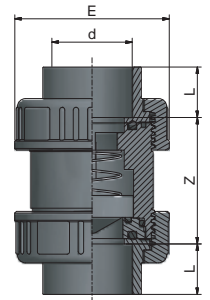
**PSPVV**
**PVC-u Check Valves Metric**

Check Valve Plain Sockets with PTFE Coated Spring FKM Seals Metric

Nominal size (d)	Code	DN	L	Z	E	PN	Price each
20	<b>RBI34I0200</b>	15	16	48	49	16	£89.20
25	<b>RBI34I0250</b>	20	19	54	60	16	£98.70
32	<b>RBI34I0320</b>	25	22	62	69	16	£104.62
40	<b>RBI34I0400</b>	32	26	69	80	16	£121.73
50	<b>RBI34I0500</b>	40	31	81	96	16	£156.14
63	<b>RBI34I0630</b>	50	39	94	116	16	£201.65
75	<b>RBI34I0750</b>	65	44	141	167	16	£448.64
90	<b>RBI34I0900</b>	80	51	140	167	16	£568.39

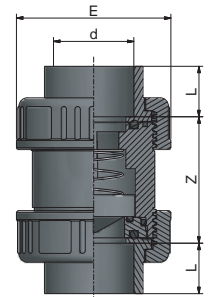



# PVC-u Check Valves Threaded Imperial

## PSPVV

### PVC-u Check Valves Threaded Imperial

Check Valve BSP Female Threaded Sockets with Stainless Steel Spring EPDM Seals

Nominal Size (Rp)	Code	DN	L min	Z max	E	PN	Price each
3/8"	RBF30F0160	15	13.2	53.6	49	16	£46.28
1/2"	RBF30F0200	15	13.2	53.6	49	16	£47.72
3/4"	RBF30F0250	20	14.5	63	60	16	£56.99
1"	RBF30F0320	25	16.8	72.4	69	16	£60.66
1 1/4"	RBF30F0400	32	19.1	82.8	80	16	£70.44
1 1/2"	RBF30F0500	40	19.1	91.8	96	16	£100.76
2"	RBF30F0630	50	23.4	103.2	116	16	£132.56
2 1/2"	RBF30F0750	65	26.7	175.6	167	16	£320.96
3"	RBF30F0900	80	29.8	153.4	167	16	£413.43
4"	RBF30F1100	100	61	157	179	10	£727.37

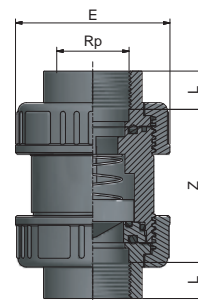

## PSPVV

### PVC-u Check Valves Threaded Imperial

Check Valve BSP Female Threaded Sockets with PTFE Coated Spring EPDM Seals

Nominal Size (d)	Code	DN	L Min	Z Max	E	PN	Price each
1/2"	RBF31F0200	15	13.2	53.6	49	16	£71.49
3/4"	RBF31F0250	20	14.5	63	60	16	£80.04
1"	RBF31F0320	25	16.8	72.4	69	16	£83.58
1 1/4"	RBF31F0400	32	19.1	82.8	80	16	£97.44
1 1/2"	RBF31F0500	40	19.1	91.8	96	16	£127.34
2"	RBF31F0630	50	23.4	103.2	116	16	£162.88
3"	RBF31F0900	80	29.8	153.4	167	16	£464.23

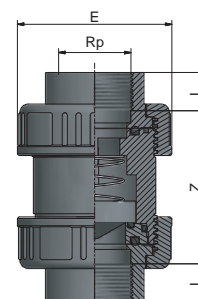

## PSPVV

### PVC-u Check Valves Threaded Imperial

Check Valve BSP Female Threaded Sockets with PTFE Coated Spring FKM Seals

Nominal size (Rp)	Code	DN	L Min	Z Max	E	PN	Price each
1/2"	RBF34F0200	15	13.2	53.6	49	16	£95.67
3/4"	RBF34F0250	20	14.5	63	60	16	£102.07
1"	RBF34F0320	25	16.8	72.4	69	16	£111.91
1 1/4"	RBF34F0400	32	19.1	82.8	80	16	£129.73
1 1/2"	RBF34F0500	40	19.1	91.8	96	16	£165.40
2"	RBF34F0630	50	23.4	103.2	116	16	£212.13
2 1/2"	RBF34F0750	65	26.7	175.6	167	16	£481.92
3"	RBF34F0900	80	29.8	153.4	167	16	£609.82

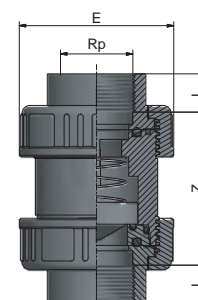

**PSPVV**

**PVC-u Check Valves Imperial**  
Ball Check Valve Threaded Sockets EPDM Seals

Nominal size (d)	Code	DN	L	Z	E	PN	Price each
1/2"	<b>CERCBE020B</b>	15	15	50	49	16	£50.11
3/4"	<b>CERCBE025C</b>	20	16.3	59.4	60	16	£59.84
1"	<b>CERCBE032D</b>	25	19.5	67	69	16	£63.69
1 1/4"	<b>CERCBE040E</b>	32	21.4	78.2	80	16	£73.96
1 1/2"	<b>CERCBE050F</b>	40	21.4	87.2	96	16	£105.80
2"	<b>CERCBE063G</b>	50	25.7	98.6	116	16	£139.19

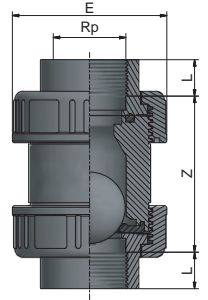

**PSPVV**

**PVC-u Check Valves Imperial**  
Ball Check Valve Threaded Sockets FKM Seals

Nominal size (d)	Code	DN	L	Z	E	PN	Price each
1/2"	<b>CERCBE020V</b>	15	15	50	49	16	£60.12
3/4"	<b>CERCBE025V</b>	20	16.3	59.4	60	16	£71.81
1"	<b>CERCBE032V</b>	25	19.5	67	69	16	£76.43
1 1/4"	<b>CERCBE040V</b>	32	21.4	78.2	80	16	£88.76
1 1/2"	<b>CERCBE050V</b>	40	21.4	87.2	96	16	£126.96
2"	<b>CERCBE063V</b>	50	25.7	98.6	116	16	£167.02

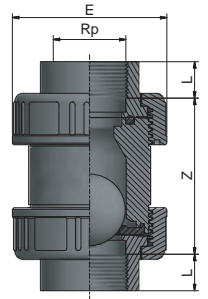

# PVC-u Wafer Check Valves

Potable water approval

Marine approval

May be used either vertically and horizontally



# PVC-u Wafer Check Valves

**PSPRA**

**PVC-u Wafer Check Valves Metric**  
Wafer Check Valve EPDM Seals

Nominal size (d)	Code	DN	E	C	Z	$\alpha$ PN6	$\alpha$ PN10	i DIN	i ANSI	PN	N	Price each
75	<b>RBA73A0750</b>	65	106	46	20	80°	75°	145	140	10	4	£147.97
90	<b>RBA73A0900</b>	80	124	58	20	80°	77°	160	152	10	4	£176.25
110	<b>RBA73A1100</b>	100	148	74	23	79°	76°	190	190	10	8	£214.67
140	<b>RBA73A1400</b>	125	188	94	25	80°	76°	210	216	10	8	£250.37
160	<b>RBA73A1600</b>	150	213	112	30	77°	75°	240	241	10	8	£301.22

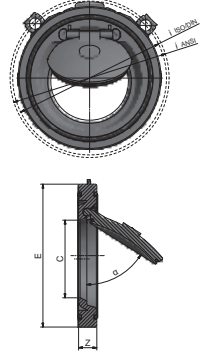

**PSPRA**

**PVC-u Wafer Check Valves Metric**  
Swing Check Valve with Spring EPDM Seals

Nominal size (d)	Code	DN	E	C	Z	$\alpha$ PN6	$\alpha$ PN10	i DIN	i ANSI	PN	N	Price each
75	<b>RBA74A0750</b>	65	106	46	20	80°	75°	145	140	10	4	£156.85
90	<b>RBA74A0900</b>	80	124	58	20	80°	77°	160	152	10	4	£186.83
110	<b>RBA74A1100</b>	100	148	74	23	79°	76°	190	190	10	8	£227.57
140	<b>RBA74A1400</b>	125	188	94	25	80°	76°	210	216	10	8	£265.38
160	<b>RBA74A1600</b>	150	213	112	30	77°	75°	240	241	10	8	£319.28

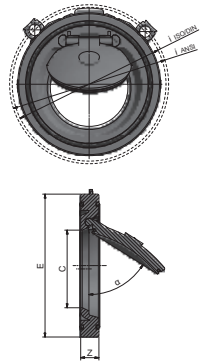

# PVC-u Air Release Valve

Potable water approval  
Marine approval  
CE Approval

1. Solvent welded sockets (ISO, BS) or threaded sockets (BSP).

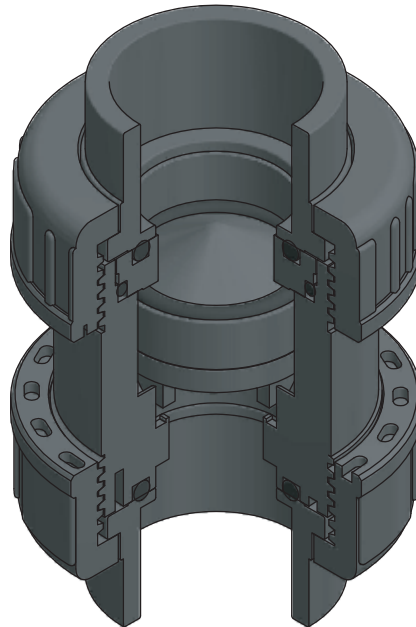

2. Without metal parts in contact with the fluid

# PVC-u Foot Valve

Potable water approval  
Marine approval  
CE Approval

1. Solvent welded sockets (ISO, BS) or threaded sockets (BSP).

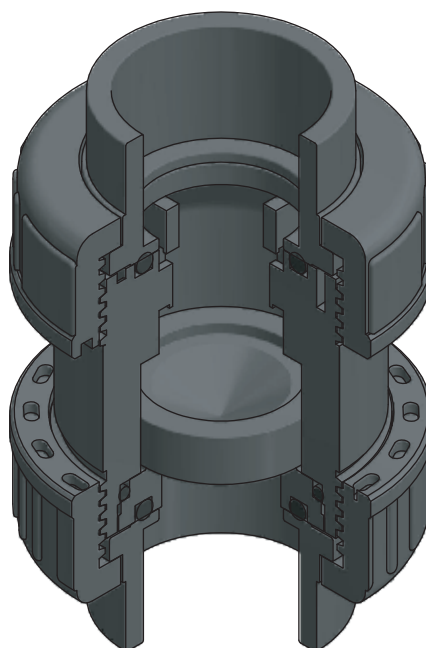

2. Without metal parts in contact with the fluid

# PVC-U Air Release and Foot Valves

**PSPVV**
**PVC-u Air Release Valves Imperial**  
 Air Release Valve Plain Sockets with EPDM Seals

Nominal size (d)	Code	DN	L	Z	E	PN	Price each
3/8"	<b>RBA33A0160</b>	15	14.5	51	49	16	£40.95
1/2"	<b>RBA33A0200</b>	15	16	48	49	16	£42.82
3/4"	<b>RBA33A0250</b>	20	19	54	60	16	£51.17
1"	<b>RBA33A0320</b>	25	22	62	69	16	£54.93
1 1/4"	<b>RBA33A0400</b>	32	26	69	80	16	£59.93
1 1/2"	<b>RBA33A0500</b>	40	31	81	96	16	£88.18
2"	<b>RBA33A0630</b>	50	39	94	116	16	£115.66
2 1/2"	<b>RBA33A0750</b>	65	44	141	167	16	£280.01
3"	<b>RBA33A0900</b>	80	51	140	167	16	£363.59
4"	<b>RBA33A1100</b>	100	61	157	179	10	£840.65

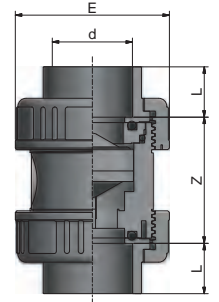
**PSPVV**
**PVC-u Air Release Valves Metric**  
 Air Release Valve Plain Sockets with EPDM Seals

Nominal size (d)	Code	DN	L	Z	E	PN	Price each
20	<b>RBI33I0200</b>	15	16	48	49	16	£42.82
25	<b>RBI33I0250</b>	20	19	54	60	16	£51.17
32	<b>RBI33I0320</b>	25	22	62	69	16	£54.93
40	<b>RBI33I0400</b>	32	26	69	80	16	£59.93
50	<b>RBI33I0500</b>	40	31	81	96	16	£88.18
63	<b>RBI33I0630</b>	50	39	94	116	16	£115.66
75	<b>RBI33I0750</b>	65	44	141	167	16	£280.01
90	<b>RBI33I0900</b>	80	51	140	167	16	£363.59
110	<b>RBI33I1100</b>	100	61	157	179	10	£645.60

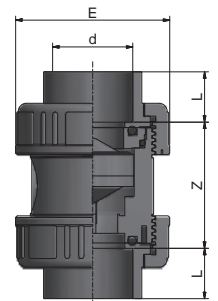

## PSPVV

### PVC-u Air Release Valves Threaded Imperial

Air Release Valve BSP Female Threaded Sockets with EPDM Seals

Nominal size (Rp)	Code	DN	L Min	Z Max	E	PN	Price each
3/8"	<b>RBF33F0160</b>	15	13.2	53.6	49	16	£40.95
1/2"	<b>RBF33F0200</b>	15	13.2	53.6	49	16	£42.82
3/4"	<b>RBF33F0250</b>	20	14.5	63	60	16	£51.17
1"	<b>RBF33F0320</b>	25	16.8	72.4	69	16	£54.93
1 1/4"	<b>RBF33F0400</b>	32	19.1	82.8	80	16	£59.93
1 1/2"	<b>RBF33F0500</b>	40	19.1	91.8	96	16	£88.18
2"	<b>RBF33F0630</b>	50	23.4	103.2	116	16	£115.66
2 1/2"	<b>RBF33F0750</b>	65	26.7	175.6	167	16	£280.01
3"	<b>RBF33F0900</b>	80	29.8	153.4	167	16	£363.59
4"	<b>RBF33F1100</b>	100	61	157	179	10	£803.95

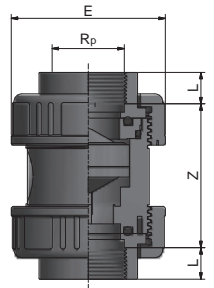

## PSFAC

### PVC-u Foot Valves Metric

Strainer for Foot Valves

Nominal size (d)	Code	Price each
1/2"	<b>CDRZVD0200</b>	£19.92
3/4"	<b>CDRZVD0250</b>	£22.92
1"	<b>CDRZVD0320</b>	£27.63
1 1/4"	<b>CDRZVD0400</b>	£32.12
1 1/2"	<b>CDRZVD0500</b>	£48.03
2"	<b>CDRZVD0630</b>	£57.52
2 1/2"	<b>CDRZVD0750</b>	£80.50
3"	<b>CDRZVD0900</b>	£81.50
4"	<b>CDRZVD1100</b>	£87.27

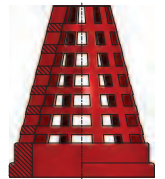

Compatible with Ball Check Valves when used as foot valves P75-82

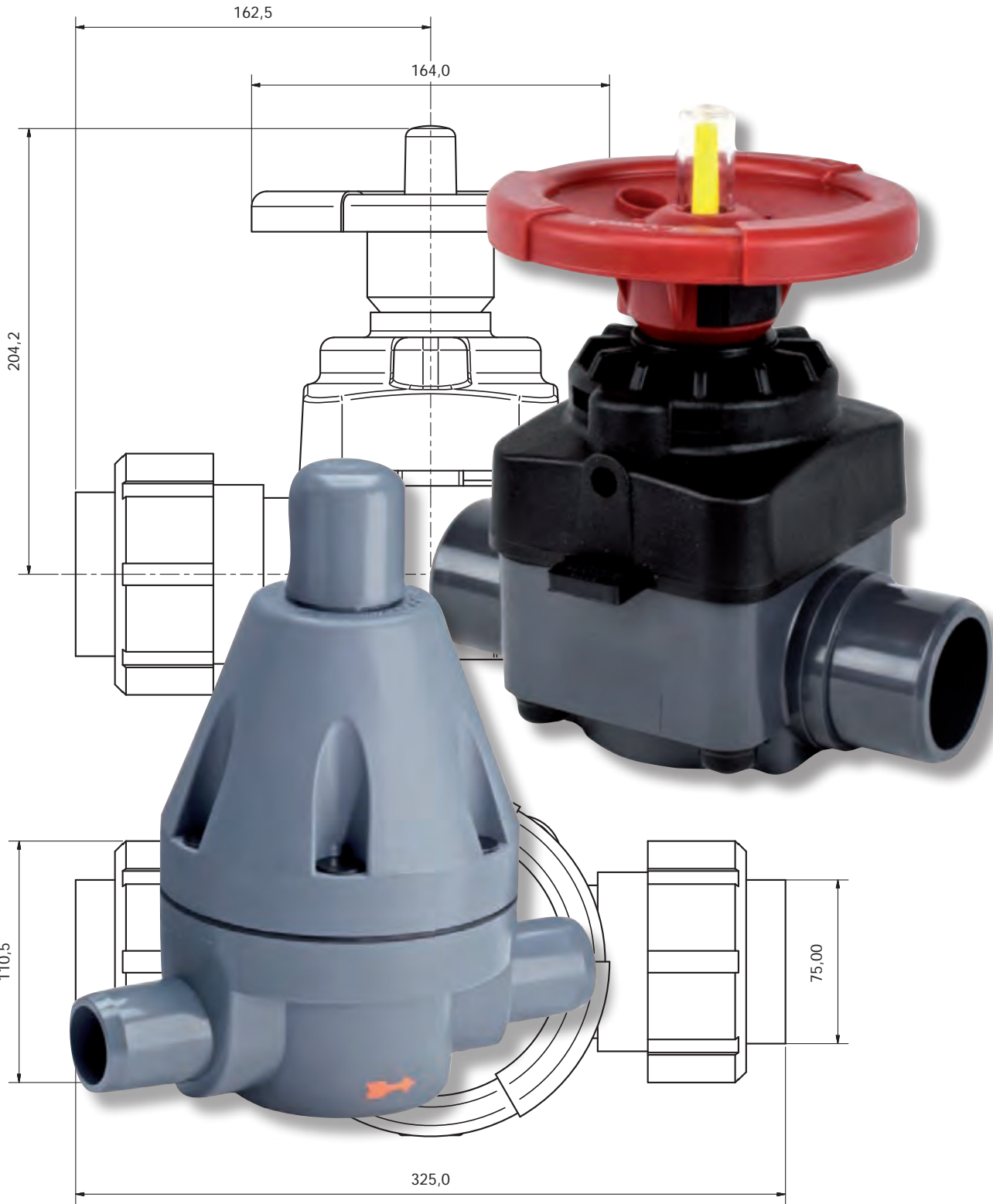

PVC-u - Valves

## PVC-u Diaphragm Valves and Pressure Reducer Valves



## Technical Features

- The diaphragm valve has a low maintenance membrane actuator which can be controlled by air or inert gases. Normally Closed (NC), Normally Open (NO) and Double Acting (DA) control functions are available. All medium wetted parts and the actuator housing are made of high-grade plastic materials which can be selected to suit the application.
- The chemical resistance of the valve is subject to the type of fluid, the temperature, the pressure, as well as the materials and seals of the valve.
- Optimized pressure drop due to body design.
- Stainless steel mounting inserts designed to support the valve. Same distance between the inserts for all DN.
- Standard handwheel
- EPDM, FKM, or PTFE diaphragm (EPDM backing).

## Materials

Diaphragm	EPDM, FKM, PTFE
Valve body	PVC-u
Screw	SS 316
Flat washer	SS 316
Protection cap	PE
Union end	PVC-u

## Flow Coefficient

Kv value	
DN	[m <sup>3</sup> /h]
15	6,1
20	9,4
25	12,2
32	24,3
40	29,3
50	45,8

## Maximum Working Pressure

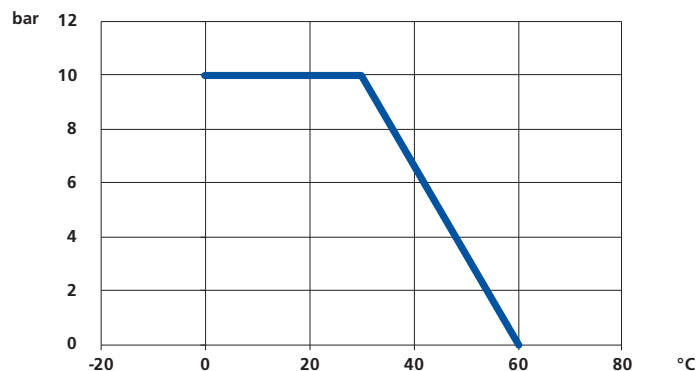

# PVC-u Diaphragm Valves

**PSAQU**
**PVC-u Diaphragm Valves Metric**  
 Diaphragm Valve Manual with DIN Flanges

Nominal size (d)	Code	DN	G	H	J	K	A	B	C	PN	Price each
20	<b>MDRMVF0200.E</b>	15	21.5	120	13	101	95	65	14	10	£210.25
25	<b>MDRMVF0250.E</b>	20	21.5	120	13	101	105	75	14	10	£239.07
32	<b>MDRMVF0320.E</b>	25	21.5	120	13	101	115	85	14	10	£263.62
40	<b>MDRMVF0400.E</b>	32	32	142	25	139	140	100	18	10	£325.46
50	<b>MDRMVF0500.E</b>	40	32	142	25	139	150	110	18	10	£346.51
63	<b>MDRMVF0630.E</b>	50	32	142	30	163	165	125	18	10	£441.35

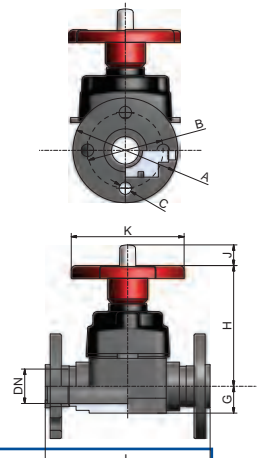

**PSAQU**
**PVC-u Diaphragm Valves Metric**  
 Diaphragm Valve Manual with Metric Spigots

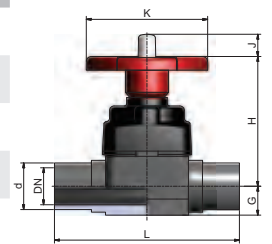
Nominal size (d)	Code	DN	L	G	H	J	K	PN	Price each
20	<b>MDRMVS0200.E</b>	15	124	21.5	120	13	101	10	£134.70
25	<b>MDRMVS0250.E</b>	20	144	21.5	120	13	101	10	£139.85
32	<b>MDRMVS0320.E</b>	25	154	21.5	120	13	101	10	£158.42
40	<b>MDRMVS0400.E</b>	32	174	32	142	25	139	10	£180.46
50	<b>MDRMVS0500.E</b>	40	194	32	142	25	139	10	£186.78
63	<b>MDRMVS0630.E</b>	50	224	39	175	30	163	10	£228.29

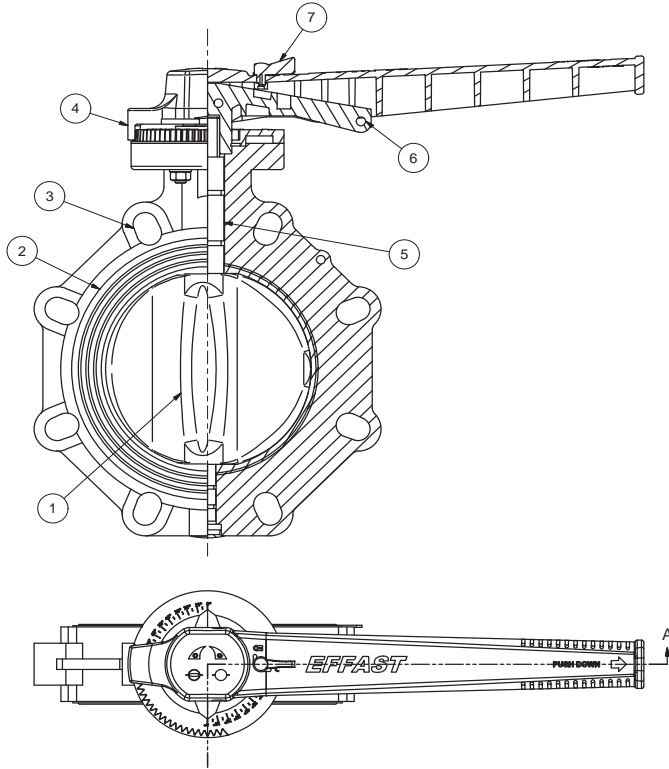

## PROFLOW P

### PVC-u Industrial Butterfly Valves



Industrial Patent n° 102015000084971 – Industrie-Patentnummer 102015000084971

## PROFLOW H

### PVC-u Butterfly Valves

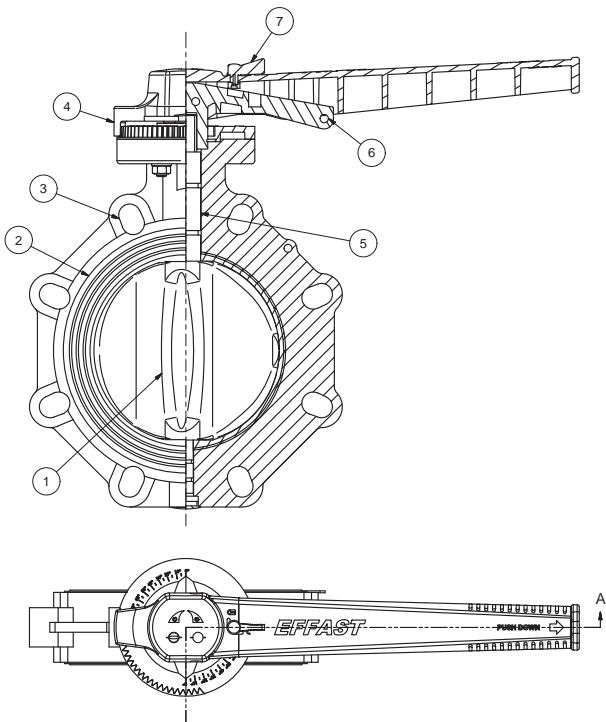

### Technical Features

- HighFlow patented disc with high flow profile. Higher flow rate and smaller pressure loss than traditional discs. The offset disc allows excellent rolling of the fluid, and then an accurate flow regulation
- PVC-u body machined to guarantee a secure seal
- EDPM or FKM certified main gasket
- SS AISI 420 B or SS AISI 316 Stem
- Ergonomic handle with closing system “push and rotate”
- Regulating plate with 19 positions between 0° and 90°
- Nominal pressure (PN): 10 bar – 145 psi (20 °C)
- Holes compatible with the international standards (DIN, ANSI, JIS)
- The valves are manufactured with a PVC-u fit for contact with potable water in accordance with regulations in U.K., Italy, France, Germany, Holland and Scandinavian countries.

### Torque: PVC-u Butterfly Valves PROFLOW P

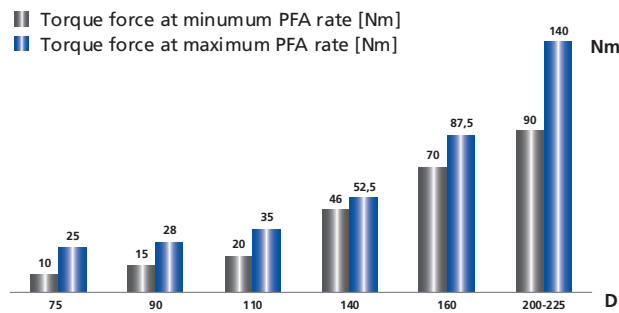

### Pressure Loss: PVC-u Butterfly Valves PROFLOW P

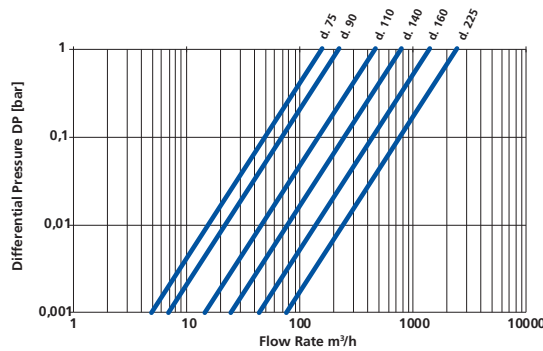

### Maximum Working Pressure: PVC-u Butterfly Valves PROFLOW P

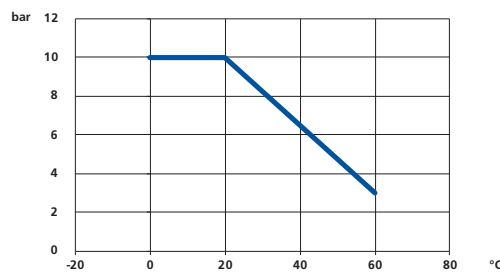

### Flow Coefficient: PVC-u Butterfly Valves PROFLOW P

d	75	90	110	140	160	200/225
<b>DN</b>	65	80	100	125	150	200
<b>Kv [m³/h]</b>	153	219	456	775	1368	2371

# PVC-u Butterfly Valves – PROFLOW P Series

Potable water approval  
Marine approval  
CE Approval



- 1. Regulation plate with 19 positions between 0° and 90°
- 2. Quick handle lock
- 3. Safety Lock
- 4. Ergonomic handle with closing system "push and rotate"

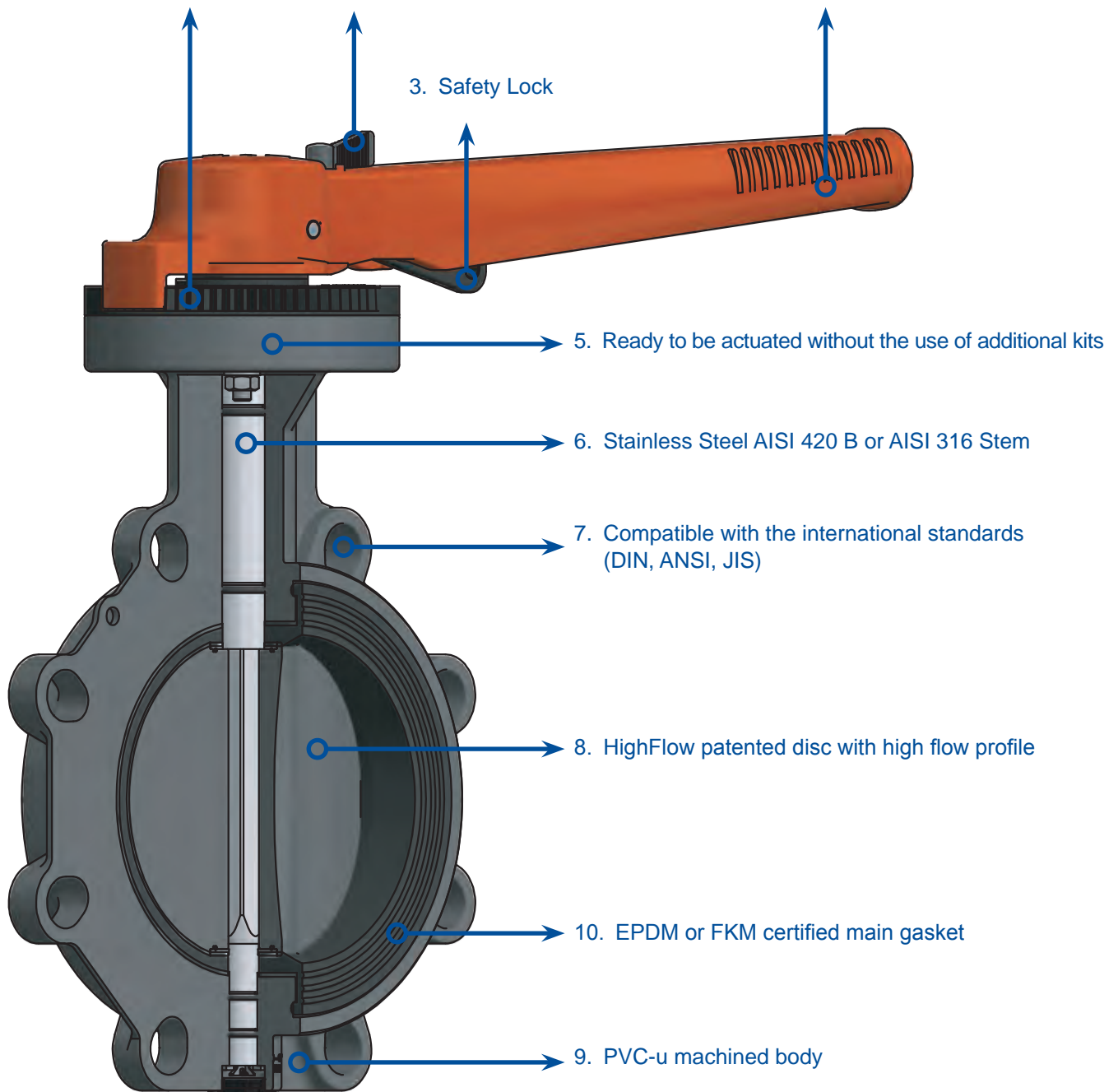

### Technical Features

- HighFlow patented disc with high flow profile. Higher flow rate and smaller pressure loss than traditional discs. The offset disc allows excellent rolling of the fluid, and then an accurate flow regulation
- PVC-u body machined to guarantee a secure seal
- EPDM certified main gasket
- Zinc plated carbon steel stem
- Ergonomic handle with closing system “push and rotate”
- Regulating plate with 19 positions between 0° and 90°
- Nominal pressure (PN): 10 bar – 145 psi (20 °C)
- Holes compatible with the international standards (DIN, ANSI, JIS)
- The valves are manufactured with a PVC-u fit for contact with potable water in accordance with regulations in U.K., Italy, France, Germany, Holland and Scandinavian countries.

### Torque: PVC-u Butterfly Valves PROFLOW H

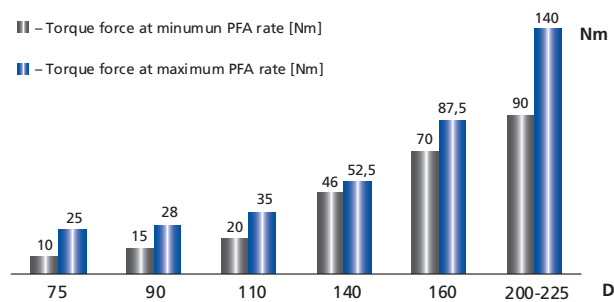

### Pressure Loss: PVC-u Butterfly Valves PROFLOW H

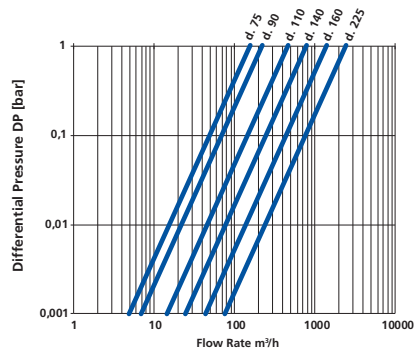

### Maximum Working Pressure: PVC-u Butterfly Valves PROFLOW H

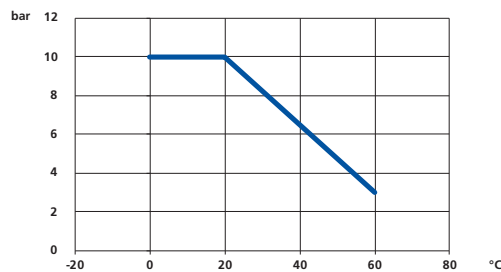

### Flow Coefficient: PVC-u Butterfly Valves PROFLOW H

d	75	90	110	140	160	200/225
DN	65	80	100	125	150	200
Kv m³/h	153	219	456	775	1368	2371

# PVC-u Butterfly Valves – PROFLOW H Series

Potable water approval  
Marine approval  
CE Approval

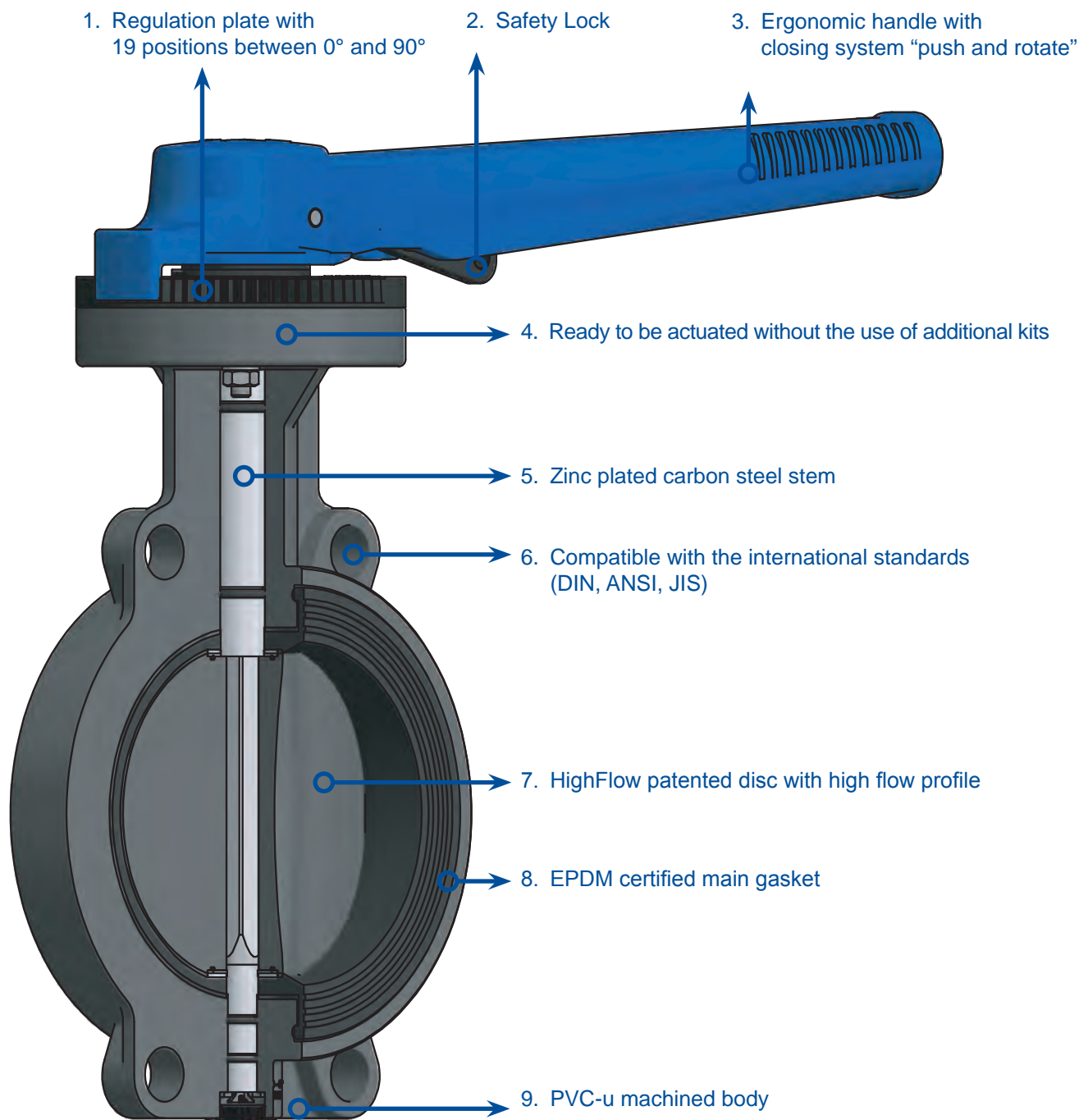

# PVC-u Butterfly Valves Imperial

**PSPRO**

**PVC-u Butterfly Valves Imperial**  
Pro Flow H Series

Nominal size (d)	Code	DN	Z	H1	H2	H3	C1	C2	B	Q	PN	Price each
2½"	<b>RBAPFH0750</b>	65	48	80	132	63	246	113	134	61	10	£253.07
3"	<b>RBAPFH0900</b>	80	59	92	132	63	246	113	139	73	10	£287.00
4"	<b>RBAPFH1100</b>	100	59.5	106	132	63	246	113	150	82	10	£313.37
5"	<b>RBAPFH1400</b>	125	65	119	159	63	246	113	185	107	10	£350.40
6"	<b>RBAPFH1600</b>	150	69	130	215	83	400	140	210	128	10	£430.54
8"	<b>RBAPFH2250</b>	200	71	159	215	83	400	140	269	177	10	£738.68

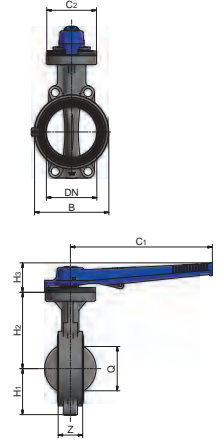

**PSPRO**

**PVC-u Butterfly Valves Imperial**  
Pro Flow P Series EPDM Seals

Nominal size (d)	Code	DN	Z	H1	H2	H3	C1	C2	B	Q	PN	Price each
2½"	<b>RBAPFP0750</b>	65	48	80	132	63	246	113	134	61	10	£452.98
3"	<b>RBAPFP0900</b>	80	59	92	132	63	246	113	139	73	10	£493.02
4"	<b>RBAPFP1100</b>	100	59.5	106	132	63	246	113	150	82	10	£553.09
5"	<b>RBAPFP1400</b>	125	65	119	159	63	246	113	185	107	10	£597.59
6"	<b>RBAPFP1600</b>	150	69	130	215	83	400	140	259	128	10	£733.85
8"	<b>RBAPFP2250</b>	200	71	159	215	83	400	140	318	177	10	£1,016.94

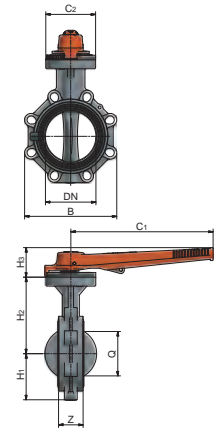

**PSPRO**

**PVC-u Butterfly Valves Imperial**  
Pro Flow P Series FKM Seals

Nominal size (d)	Code	DN	Z	H1	H2	H3	C1	C2	B	Q	PN	Price each
2½"	<b>RBAPFP075F</b>	65	48	80	132	63	246	113	134	61	10	£600.05
3"	<b>RBAPFP090F</b>	80	59	92	132	63	246	113	139	73	10	£739.46
4"	<b>RBAPFP110F</b>	100	59.5	106	132	63	246	113	150	82	10	£893.78
5"	<b>RBAPFP140F</b>	125	65	119	159	63	246	113	185	107	10	£930.87
6"	<b>RBAPFP160F</b>	150	69	130	215	83	400	140	259	128	10	£1,234.36
8"	<b>RBAPFP225F</b>	200	71	159	215	83	400	140	318	177	10	£1,794.18

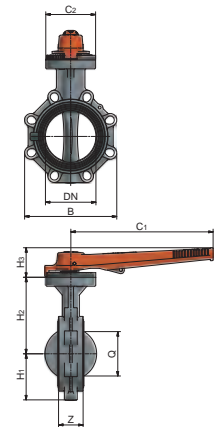

PVC-u - Valves



# PVC-u Butterfly Valves Metric

## PSPRO

**PVC-u Butterfly Valves Metric**  
Pro Flow H Series Butterfly Valve—Complete EDPM O Rings

Nominal size	Code	DN	L	Z	H1	H2	C1	C2	E	n	M x L	Price each
75	<b>RBIFBH0750</b>	65	44	58	132	63	246	113	185	4	M16 x 130	£353.85
90	<b>RBIFBH0900</b>	80	52	67	132	63	246	113	200	8	M16 x 140	£431.16
110	<b>RBIFBH1100</b>	100	62	67.5	132	63	246	113	220	8	M16 x 160	£457.31
140	<b>RBIFBH1400</b>	125	78	81	159	63	246	113	250	8	M16 x 180	£569.78
160	<b>RBIFBH1600</b>	150	87	81	215	83	400	140	285	8	M20 x 200	£626.51
225	<b>RBIFBH2250</b>	200	119	87	215	83	400	140	340	8	M20 x 200	£874.32

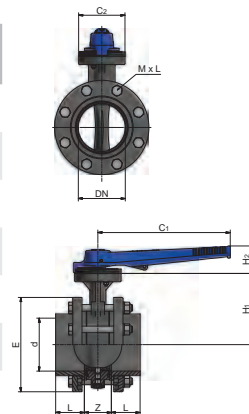

## PSPRO

**PVC-u Butterfly Valves Metric**  
Pro Flow P Series Butterfly Valve—Complete EDPM or FKM Seals

Nominal size	Code	DN	L	Z	H1	H2	C1	C2	E	n	M x L	Price each
75	<b>RBIFBP0750</b>	65	44	58	132	63	246	113	185	4	M16 x 130	£562.36
90	<b>RBIFBP0900</b>	80	52	67	132	63	246	113	200	8	M16 x 140	£643.14
110	<b>RBIFBP1100</b>	100	62	67.5	132	63	246	113	220	8	M16 x 160	£720.07
140	<b>RBIFBP1400</b>	125	78	81	159	63	246	113	250	8	M16 x 180	£771.42
160	<b>RBIFBP1600</b>	150	87	81	215	83	400	140	285	8	M20 x 200	£927.71
225	<b>RBIFBP2250</b>	200	119	87	215	83	400	140	340	8	M20 x 200	£1,276.13

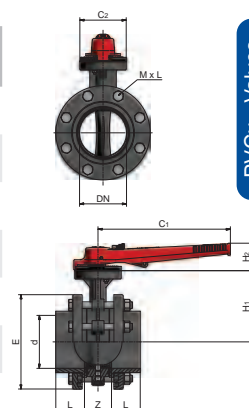

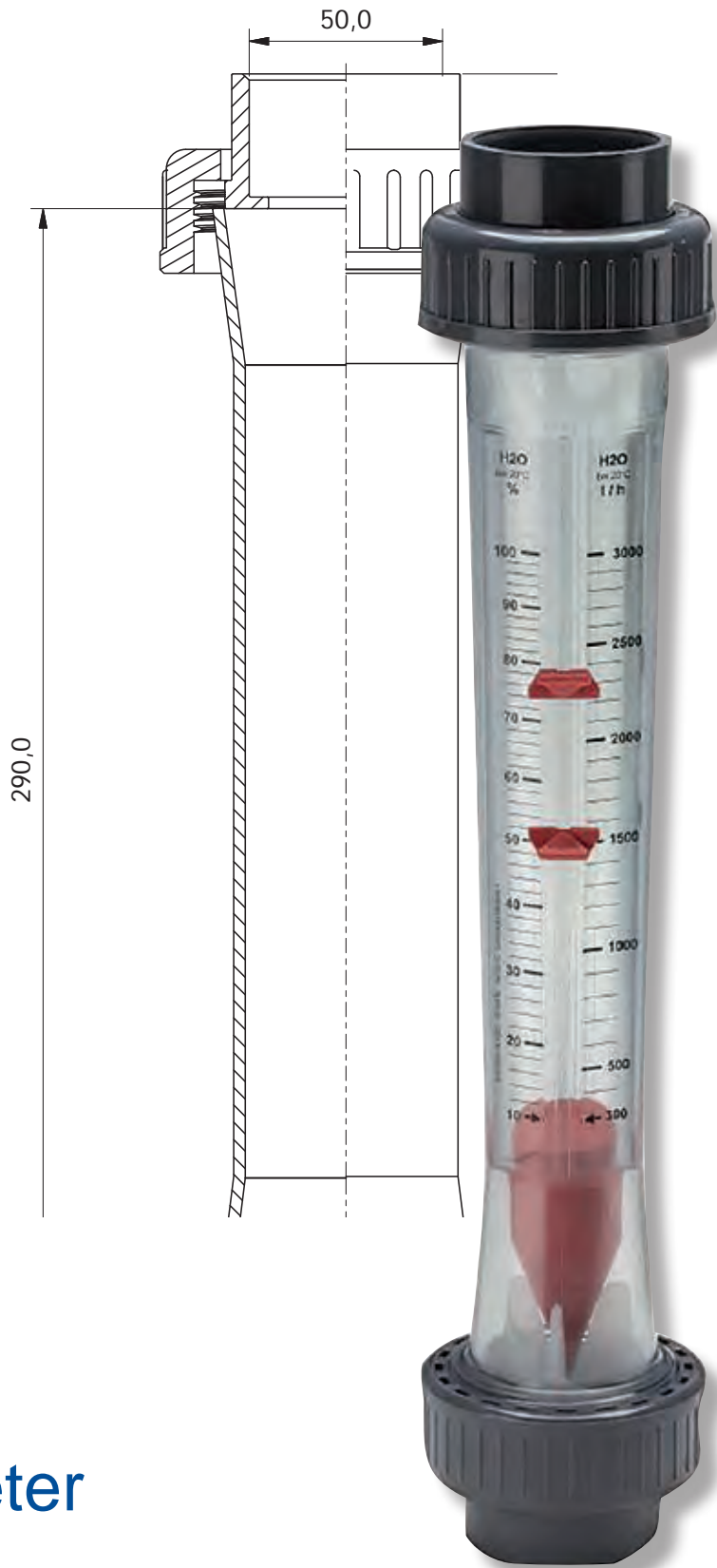

# PVC-u Flowmeter

## Function

The flow meter operates on the float principle and is used for flow rate measurements in closed pipelines.

The medium flows through the vertically installed flow meter from bottom to top.

This raises the float and shows the current flow rate on the scale on the measuring device. The read-off edge corresponds to the largest diameter of the float.

The flow meters come as standard with a water scale and a % scale, and two setpoint indicators.

## Special Features

- Fracture-proof and corrosion-resistant
- Radially removable
- Special adhesive scales for liquid and gaseous media
- Holder for accessories (limit value contacts)
- Measuring tube carries the DN label, and also the measuring range and material
- PVDF floats and stops as standard
- Operating pressure PN 10 bar at 20 °C

## Pressure Loss: Flowmeters Measuring range 50-60000L/h

Measuring range l/h	50 / 500	100 – 1.000	150 – 1.500	250 – 2.500	200 – 2.000	300 – 3.000
Pressure loss mbar	22.84	22.84	22.84	22.84	24.99	24.99
Measuring range l/h	600 – 6.000	1.000 – 10.000	1.500 – 15.000	2.000 – 20.000	3.000 – 30.000	8.000 – 60.000
Pressure loss mbar	24.99	24.99	28.23	45.67	45.67	47.24

## Measuring Accuracy Flowmeters Measuring range 50-60000L/h

Flow in %	10	20	30	40	50	60	70	80	90	100
Total measured value error in %	13.00	8.00	6.33	5.50	5.00	4.67	4.43	4.25	4.11	4.00
Total limit value error in %	1.3	1.6	1.9	2.2	2.5	2.9	3.1	3.4	3.7	4.0

## Pressure Loss: Flowmeters Measuring range 1.5-1000L/h

Measuring range l/h	1.5-15	2.5-25	5-50	10-100	8-80	15-150	20-200	15-150	30-300	50-500	100-1.000
Pressure loss mm WS	46.0	46.0	46.0	46.0	44.7	44.7	44.7	82.8	82.8	82.8	82.8
Measuring range l/h	1.5-15	2.5-25	5-50	10-100	8-80	15-150	20-200	15-150	30-300	50-500	100-1.000
Pressure loss mbar	4.6	4.6	4.6	4.6	4.47	4.47	4.47	8.28	8.28	8.28	8.28

## Measuring Accuracy:Flowmeters Measuring range 1.5-1000L/h

Flow in %	10	20	30	40	50	60	70	80	90	100
Total measured value error in %	13.00	8.00	6.33	5.50	5.00	4.67	4.43	4.25	4.11	4.00
Total limit value error in %	1.3	1.6	1.9	2.2	2.5	2.9	3.1	3.4	3.7	4.0

# PVC-u Flowmeter

**PSAQU**
**PVC-u Flowmeter**

Flowmeter with Transparent PVCu Body and PVDF Float Debitmeters

Code	Description	DN	Price each
HDRFLU016A	PVC 16 1.5-15	16/1.5-15	£259.98
HDRFLU016B	PVC 16mm-mm range 2.5-25	16/2.5-25	£259.98
HDRFLU016C	PVC 16mm-mm range 5-50	16/5-50	£259.98
HDRFLU016D	PVC 16mm-mm range 10-100	16/10-100	£259.98
HDRFLU020A	PVC 20mm-mm range 8-80	20/8-80	£265.49
HDRFLU020B	PVC 20mm-mm range 15-150	20/15-150	£265.49
HDRFLU020C	PVC 20mm-mm range 20-200	20/20-200	£265.49
HDRFLU032AE	PVC 32mm-mm range 15-150	32/15-150	£312.51
HDRFLU032BC	PVC 32mm-mm range 30-300	32/30-300	£312.51
HDRFLU032CC	PVC 32mm-mm range 50-500	32/50-500	£312.51
HDRFLU032DC	PVC 32mm-mm range 100-1000	32/100-1000	£312.51
HDRFLU032C	PVC 32mm-mm range 50-500	32/50-500	£392.94
HDRFLU032D	PVC 32mm-mm range 100-1000	32/100-1000	£400.14
HDRFLU040A	PVC 40mm-mm range 150-1500	40/150-1500	£458.89
HDRFLU040B	PVC 40mm-mm range 250-2500	40/250-2500	£494.87
HDRFLU050A	PVC 50mm-mm range 200-2000	50/200-2000	£512.30
HDRFLU050B	PVC 50mm-mm range 300-3000	50/300-3000	£684.75
HDRFLU050C	PVC 50mm-mm range 600-6000	50/600-6000	£735.09
HDRFLU063B	PVC 63mm-mm range 600-6000	63/600-6000	£853.50
HDRFLU063C	PVC 63mm-mm range 1000-10000	63/1000-10000	£918.17
HDRFLU063D	PVC 63mm-mm range 1500-15000	63/1500-15000	£1,006.78
HDRFLU075A	PVC 75mm-mm range 2000-20000	75/2000-20000	£1,008.59
HDRFLU075B	PVC 75mm-mm range 3000-30000	75/3000-30000	£1,008.59
HDRFLU075C	PVC 75mm-mm range 8000-60000	75/8000-60000	£1,020.55



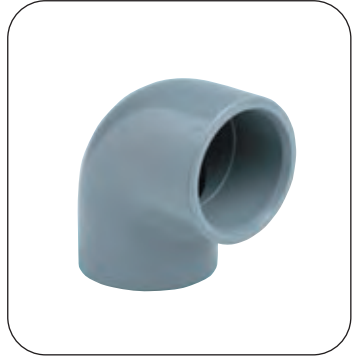
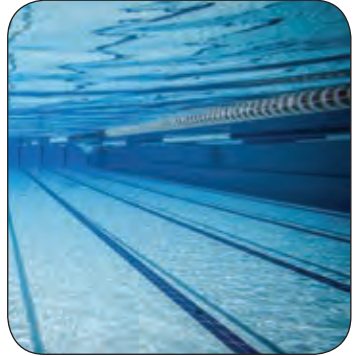
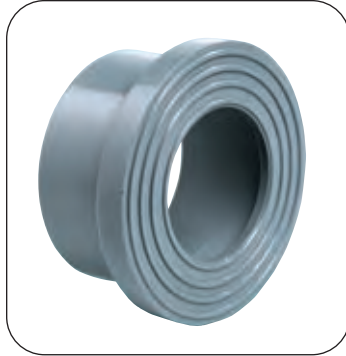
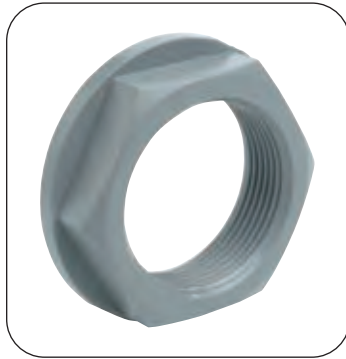

## ABS Valves, Pipes and Fittings

ABS (Acrylonitrile Butadiene Styrene) is highly rated as a thermoplastic pipework system and is used in many applications such as food and beverage processing as well as water and sewerage treatment and many other industries.

ABS has good chemical resistance with high impact strength and low moisture absorption. ABS is non-toxic and conforms to the toxicological requirements of the British Plastic Federation, British Industrial Biological Research Association Code of Practice for food usage 45/5.

It also fulfils the EEC requirements for plastic materials in contact with foodstuffs.

ABS systems are lightweight, rigid and easy to install using a solvent cement.

## Colour

ABS products are recognised by their light grey colour (RAL 7046).

## Chemical Resistance

Effast ABS has good resistance to most diluted inorganic acids, salts, animal fats and oils and organic acids. It is not resistant to organic solvents, alcohol, petrol, acetic acid or vegetable oils.

Recommendations can be given by our Technical Department regarding the resistance of ABS to specific chemicals. Alternatively, see pages 155 - 159 for a Guide to Chemical Resistance.

## Thermal expansion

The thermal coefficient of linear expansion for ABS is  $10.1 \times 10^{-5} \text{ m/m } ^\circ\text{C}$ . It is necessary in certain situations to make special provision for this expansion and contraction. Thermal expansion of ABS is compared with other materials, in the following chart.

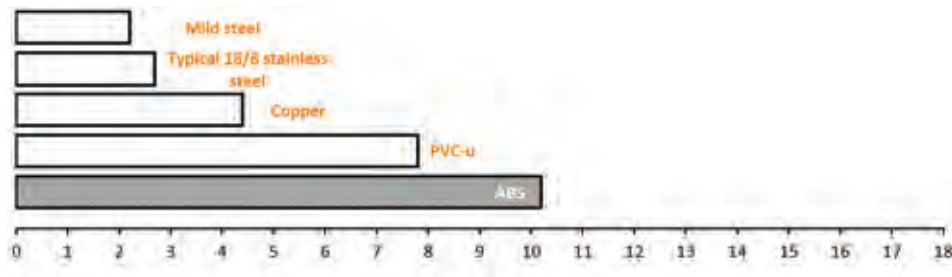

## Temperature range

-40 °C to +60 °C

## Standards

- BS 5392

Acrylonitrile-butadiene-styrene (ABS) fittings for use with ABS pressure pipe. Specification

- BS 5391

Acrylonitrile-butadiene-styrene (ABS) pressure pipe. Specification.

- EN 10226-1

Pipe threads where pressure tight joints are made on the threads – Part 1: Taper external threads and parallel internal threads – Dimensions, tolerances and designation.

- DIN 2999

Pipe threads for tubes and fittings; parallel internal thread and taper external thread

- DIN DVS 2204-3

Adhesive bonding of thermoplastic pipes and pipe components – Acrylonitrile butadiene styrene (ABS).



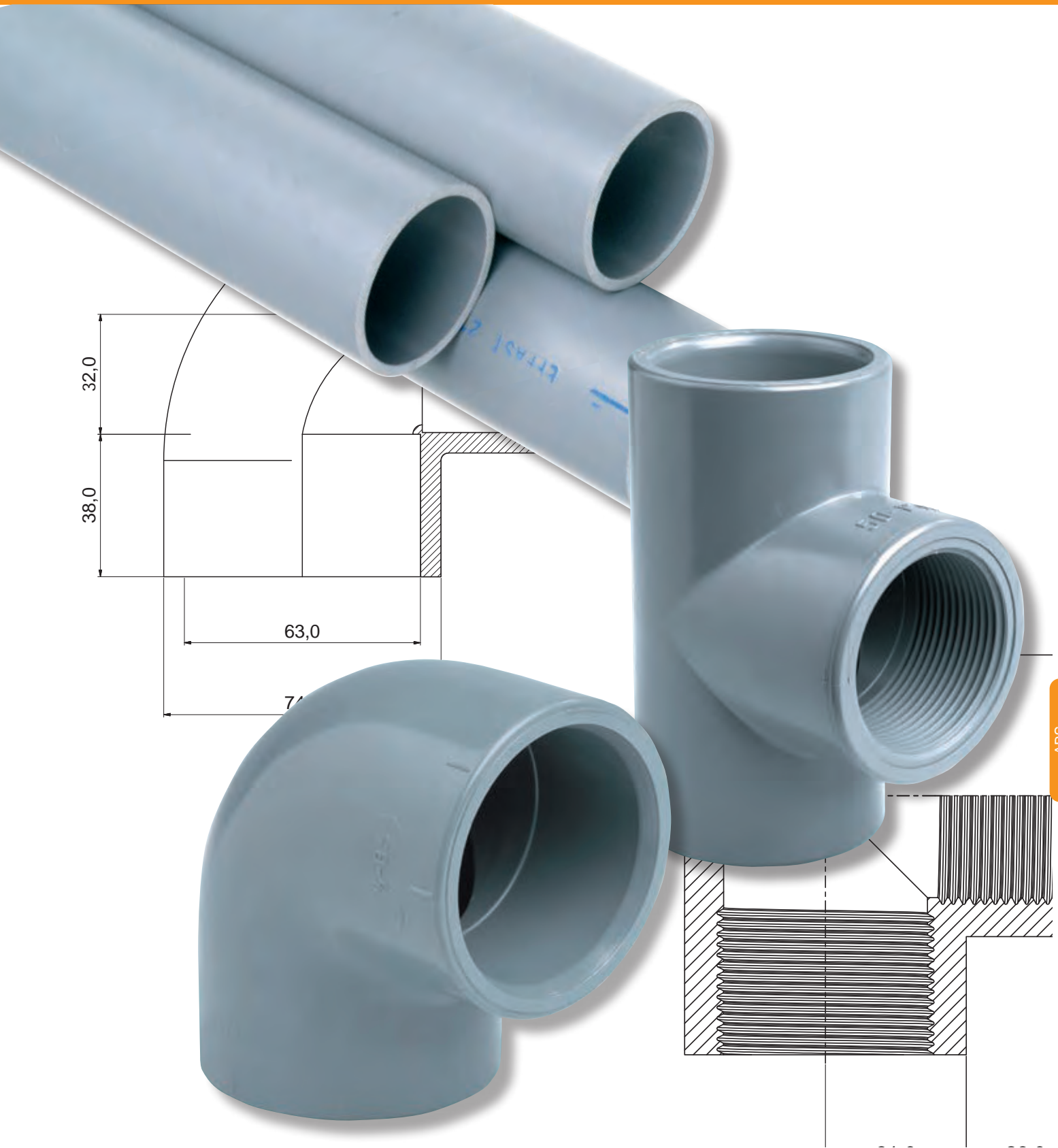

ABS

## ABS Pipes and Fittings

---

# ABS Pressure Pipes 3m Plain End Imperial

**PSABP**
**ABS Pressure Pipes 3m Plain End Imperial**  
 Pressure Pipe Class C - 3 Metre (9 Bar at 20°C)

Nominal size (d)	Code	Price per metre	Price each
1"	APCCLC03203	£9.40	£28.20
1¼"	APCCLC04003	£15.78	£47.35
1½"	APCCLC05003	£20.05	£60.15
2"	APCCLC06303	£26.96	£80.88
2½"	APCCLC07503	£46.66	£139.98
3"	APCCLC09003	£55.76	£167.28
4"	APCCLC11003	£91.65	£274.94
5"	APCCLC14003	£192.48	£577.45
6"	APCCLC16003	£202.01	£606.03
8"	APCCLC22503	£385.69	£1,157.08

**PSABP**
**ABS Pressure Pipes 3m Plain End Imperial**  
 Pressure Pipe Class E - 3 Metre (15 Bar at 20°C)

Nominal size (d)	Code	Price per metre	Price each
½"	APECLE02003	£7.15	£21.46
¾"	APECLE02503	£11.04	£33.12
1"	APECLE03203	£14.55	£43.65
1¼"	APECLE04003	£21.70	£65.10
1½"	APECLE05003	£28.61	£85.84
2"	APECLE06303	£35.89	£107.68
3"	APECLE09003	£71.95	£215.85
4"	APECLE11003	£115.89	£347.66

**PSABP**
**ABS Pressure Pipes 3m Plain End Imperial**  
 Pressure Pipe Class T - 3 Metre (machining quality max. 12 bar at 20°C)

Nominal size (d)	Code	Price per metre	Price each
½"	APTCLT02003	£12.38	£37.14
¾"	APTCLT02503	£14.04	£42.13
1"	APTCLT03203	£20.06	£60.17
1¼"	APTCLT04003	£35.09	£105.28
1½"	APTCLT05003	£35.48	£106.45
2"	APTCLT06303	£48.34	£145.01





# ABS Pressure Pipes 6m Plain End Imperial

**PSABP**

**ABS Pressure Pipes 6m Plain End Imperial**  
Pressure Pipe Class C - 6 Metre (9 Bar at 20°C)

Nominal size (d)	Code	Price per metre	Price each
1"	APCCLC0320	£9.39	£56.36
1¼"	APCCLC0400	£15.78	£94.70
1½"	APCCLC0500	£20.04	£120.26
2"	APCCLC0630	£26.96	£161.74
2½"	APCCLC0750	£46.66	£279.97
3"	APCCLC0900	£55.77	£334.59
4"	APCCLC1100	£91.64	£549.84
5"	APCCLC1400	£192.48	£1,154.88
6"	APCCLC1600	£192.57	£1,155.44
8"	APCCLC2250	£385.70	£2,314.18



**PSABP**

**ABS Pressure Pipes 6m Plain End Imperial**  
Pressure Pipe Class E - 6 Metre (15 Bar at 20°C)

Nominal size (d)	Code	Price per metre	Price each
½"	APECLE0200	£7.16	£42.94
¾"	APECLE0250	£11.04	£66.24
1"	APECLE0320	£14.55	£87.32
1¼"	APECLE0400	£21.70	£130.18
1½"	APECLE0500	£28.61	£171.66
2"	APECLE0630	£35.90	£215.39
3"	APECLE0900	£71.95	£431.71
4"	APECLE1100	£115.89	£695.34



ABS - Pipes

**PSABP**

**ABS Pressure Pipes 6m Plain End Imperial**  
Pressure Pipe Class T - 6 Metre (machining quality max. 12 bar at 20°C)

Nominal size (d)	Code	Price per metre	Price each
½"	APTCLT0200	£12.39	£74.33
¾"	APTCLT0250	£14.05	£84.30
1"	APTCLT0320	£20.05	£120.30
1¼"	APTCLT0400	£35.09	£210.55
1½"	APTCLT0500	£35.49	£212.93
2"	APTCLT0630	£48.34	£290.06



# ABS Solvent Cement Fittings Imperial

**PSABF**

**ABS Solvent Cement Fittings Imperial**  
Socket Plain

Nominal size (d)	Code	L	Z	E	PN	Price each
½"	AFAMAA0200	17	3	27	15	£2.45
¾"	AFAMAA0250	20	3	33	15	£2.78
1"	AFAMAA0320	23	3	41	15	£3.13
1¼"	AFAMAA0400	27	3	50	15	£5.38
1½"	AFAMAA0500	32	3	61	15	£6.41
2"	AFAMAA0630	38	3	76	15	£9.13
2½"	AFAMAA0750	44	3	90	15	£19.74
3"	AFAMAA0900	51	5	110	15	£36.33
4"	AFAMAA1100	63	6	133	15	£51.72
5"	AFAMAA1400	76	8	161	15	£100.37
6"	AFAMAA1600	90	8	198	15	£128.77
8"	AFAMAA2250	119	11	258	9	£339.10

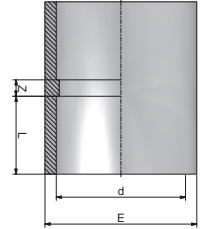

**PSABF**

**ABS Solvent Cement Fittings Imperial**  
Union Plain

Nominal size (d)	Code	L	F	Z	H	E	PN	Price each
½"	AFABOA0200	16	1"	13	45	43	15	£12.62
¾"	AFABOA0250	19	1¼"	13	51	54	15	£13.72
1"	AFABOA0320	22	1½"	13	57	60	15	£18.54
1¼"	AFABOA0400	27	2"	14	68	75	15	£22.61
1½"	AFABOA0500	31	2¼"	18	80	81	15	£31.11
2"	AFABOA0630	38	2¾"	22	98	99	15	£40.64
2½"	AFABOA0750	44	3½"	22	110	120	15	£98.36
3"	AFABOA0900	51	4"	23	125	134	15	£150.48
4"	AFABOA1100	61	5"	23	145	163	15	£202.68

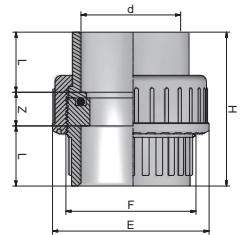

**PSABF**

**ABS Solvent Cement Fittings Imperial**  
Elbow 90° Plain

Nominal size (d)	Code	L	Z	E	PN	Price each
½"	<b>AFAGOA0200</b>	17	11	27	15	£3.26
¾"	<b>AFAGOA0250</b>	20	14	33	15	£3.90
1"	<b>AFAGOA0320</b>	23	17	41	15	£5.32
1¼"	<b>AFAGOA0400</b>	27	23	51	15	£9.13
1½"	<b>AFAGOA0500</b>	32	28	61	15	£11.79
2"	<b>AFAGOA0630</b>	38	34	75	15	£17.80
2½"	<b>AFAGOA0750</b>	44	40	89	15	£34.24
3"	<b>AFAGOA0900</b>	52	48	106	15	£51.34
4"	<b>AFAGOA1100</b>	63	58	133	15	£76.57
5"	<b>AFAGOA1400</b>	76	72	164	15	£176.61
6"	<b>AFAGOA1600</b>	90	81	198	15	£306.99
8"	<b>AFAGOA2250</b>	119	115	258	9	£620.11

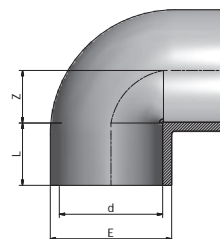

**PSABF**

**ABS Solvent Cement Fittings Imperial**  
Elbow 45° Plain

Nominal size (d)	Code	L	Z	E	PN	Price each
½"	<b>AFAGYA0200</b>	17	5	27	15	£6.22
¾"	<b>AFAGYA0250</b>	20	6	33	15	£6.31
1"	<b>AFAGYA0320</b>	23	8	41	15	£8.06
1¼"	<b>AFAGYA0400</b>	27	10	50	15	£11.50
1½"	<b>AFAGYA0500</b>	32	12	61	15	£14.45
2"	<b>AFAGYA0630</b>	38	15	75	15	£19.88
2½"	<b>AFAGYA0750</b>	44	18	89	15	£31.40
3"	<b>AFAGYA0900</b>	52	21	106	15	£46.68
4"	<b>AFAGYA1100</b>	63	25	133	15	£97.01
6"	<b>AFAGYA1600</b>	90	36	198	15	£201.41
8"	<b>AFAGYA2250</b>	119	49	258	9	£623.80

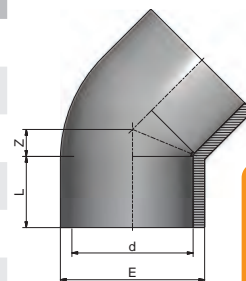

ABS- Fittings

## PSABF

### ABS Solvent Cement Fittings Imperial Bend 90° Short Radius Plain

Nominal size (d)	Code	L	Z	E	PN	Price each
½"	AFACUA0200	16	40	28	15	£11.88
¾"	AFACUA0250	20	49	33	15	£13.85
1"	AFACUA0320	22	64	42	15	£20.34
1¼"	AFACUA0400	26	80	51	15	£29.16
1½"	AFACUA0500	31	100	63	15	£36.51
2"	AFACUA0630	38	126	77	15	£62.60
2½"	AFACUA0750	44	150	94	15	£100.76
3"	AFACUA0900	51	180	113	15	£123.88
4"	AFACUA1100	61	220	132	15	£247.93

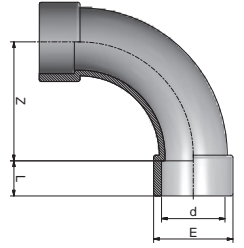

## PSABF

### ABS Solvent Cement Fittings Imperial Tee 90° Plain

Nominal size (d)	Code	L	Z	E	PN	Price each
½"	AFATIA0200	17	11	28	15	£5.00
¾"	AFATIA0250	20	14	34	15	£5.08
1"	AFATIA0320	23	17	42	15	£7.12
1¼"	AFATIA0400	27	21	51	15	£10.10
1½"	AFATIA0500	32	26	61	15	£14.77
2"	AFATIA0630	38	33	75	15	£22.61
2½"	AFATIA0750	44	39	89	15	£39.05
3"	AFATIA0900	51	47	106	15	£65.92
4"	AFATIA1100	63	57	133	15	£96.80
5"	AFATIA1400	76	71	163	15	£256.77
6"	AFATIA1600	90	81	198	15	£338.25
8"	AFATIA2250	119	114	258	9	£693.39

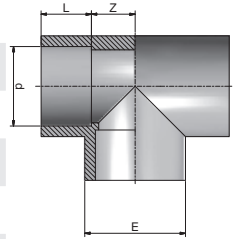

## PSABF

### ABS Solvent Cement Fittings Imperial Tee 45° Plain

Nominal size (d)	Code	L	Z	E	PN	Price each
1"	AFATYA0320	23	8	44	16	£18.48
1½"	AFATYA0500	31	12	65	16	£32.61
2"	AFATYA0630	38	14	85	16	£60.89

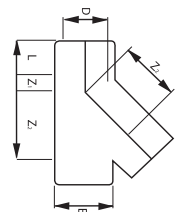

## PSABF

### ABS Solvent Cement Fittings Imperial Cross 90° Plain

Nominal size (d)	Code	L	Z	E	PN	Price each
1"	<b>AFACXA0320</b>	23	17	42	16	£14.81
1½"	<b>AFACXA0500</b>	31	26	61	16	£36.09
2"	<b>AFACXA0630</b>	38	33	75	16	£83.77

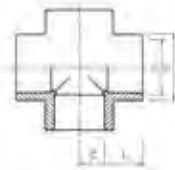

## PSABF

### ABS Solvent Cement Fittings Imperial Reducing Socket Plain

Nominal size (d)	Code	d	L2	Z	E1	E2	PN	Price each
1¼" x 1"	<b>AFAMRA040D</b>	27	23	5	51	42	16	£11.98
1½" x 1¼"	<b>AFAMRA050E</b>	32	27	5	61	52	16	£15.18
2" x 1½"	<b>AFAMRA063F</b>	39	32	5	75	62	16	£26.04
4" x 3"	<b>AFAMRA110I</b>	63	52	4	130	108	16	£64.60

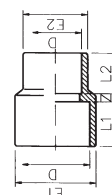

## PSABF

### ABS Solvent Cement Fittings Imperial Reducing Bush Plain

Nominal Size (d x d1)	Code	L	d	d1	Z	PN	Price each
¾" x ½"	<b>AFARCA025B</b>	17	¾"	½"	3	15	£2.47
1" x ½"	<b>AFARCA032B</b>	17	1"	½"	6	15	£3.36
1" x ¾"	<b>AFARCA032C</b>	20	1"	¾"	3	15	£3.20
1¼" x 1"	<b>AFARCA040D</b>	23	1¼"	1"	4	15	£4.14
1½" x ¾"	<b>AFARCA050C</b>	20	1½"	¾"	12	15	£5.62
1½" x 1"	<b>AFARCA050D</b>	23	1½"	1"	9	15	£5.35
1½" x 1¼"	<b>AFARCA050E</b>	27	1½"	1¼"	5	15	£5.62
2" x 1"	<b>AFARCA063D</b>	23	2"	1"	16	15	£7.52
2" x 1¼"	<b>AFARCA063E</b>	27	2"	1¼"	11	15	£7.52
2" x 1½"	<b>AFARCA063F</b>	32	2"	1½"	6	15	£7.16
2½" x 1½"	<b>AFARCA075F</b>	32	2½"	1½"	13	15	£12.72
2½" x 2"	<b>AFARCA075G</b>	38	2½"	2"	6	15	£12.72
3" x 1½"	<b>AFARCA090F</b>	32	3"	1½"	20	15	£21.97
3" x 2"	<b>AFARCA090G</b>	38	3"	2"	14	15	£21.97
3" x 2½"	<b>AFARCA090H</b>	44	3"	2½"	8	15	£21.97
4" x 2"	<b>AFARCA110G</b>	38	4"	2"	23	15	£27.42
4" x 3"	<b>AFARCA110I</b>	52	4"	3"	9	15	£27.42
5" x 4"	<b>AFARCA140L</b>	63	5"	4"	15	15	£79.16
6" x 4"	<b>AFARCA160L</b>	63	6"	4"	26	15	£84.43
8" x 6"	<b>AFARCA225M</b>	86	8"	6"	23	15	£303.96

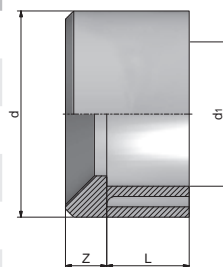

## PSABF

### ABS Solvent Cement Fittings Imperial Cap Plain

Nominal size (d)	Code	L	H	E	PN	Price each
½"	AFACAA0200	17	30	27	15	£2.35
¾"	AFACAA0250	20	34	33	15	£2.83
1"	AFACAA0320	23	38	42	15	£3.20
1¼"	AFACAA0400	27	43	50	15	£5.10
1½"	AFACAA0500	32	48	61	15	£7.80
2"	AFACAA0630	38	56	75	15	£10.21
2½"	AFACAA0750	44	67	89	15	£25.48
3"	AFACAA0900	51	78	106	15	£29.98
4"	AFACAA1100	63	81	133	15	£63.91
6"	AFACAA1600	90	127	198	15	£121.83
8"	AFACAA2250	119	165	255	9	£312.83

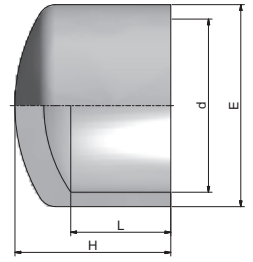

# ABS Flanges Imperial

**PSABF**

**ABS Flanges Imperial**  
Stub Flange (Serrated Face) Plain

Nominal size (d)	d1	Code	L	S	Z	E	PN	Price each
½"	27	AFAQRA0200	16	6	3	34	15	£2.23
1"	41	AFAQRA0320	22	7	4	50	15	£3.60
1½"	61	AFAQRA0500	32	9	4	73	15	£9.65
2"	76	AFAQRA0630	38	10	4	90	15	£14.77
2½"	90	AFAQRA0750	44	10	5	106	15	£23.43
3"	108	AFAQRA0900	52	11	4	125	15	£28.98
4"	131	AFAQRA1100	62	12	5	149	15	£37.51
5"	165	AFAQRA1400	77	13	8	189	15	£86.09
6"	188	AFAQRA1600	87	13	7	214	15	£97.37
8"	248	AFAQRA2250	119	20	9	273	9	£255.56

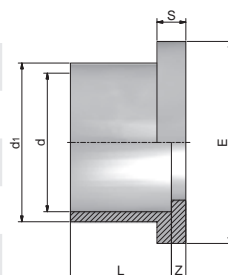

**PSABF**

**ABS Flanges Imperial**  
Full Face Flange Drilled to BS 10 Table E Plain

Nominal size (d)	Code	L	S	i	f	Z	E	n° x M	PN	Price each
1½"	AFAFFA0500	4.5	16	110	18	152	31	4 x M16	15	£21.06
2"	AFAFFA0630	4.5	20	125	18	165	38	4 x M16	15	£36.45
3"	AFAFFA0900	7	22	160	18	200	51	8 x M16	15	£52.22
4"	AFAFFA110E	8	23	180	18	220	61	8 x M16	15	£66.35

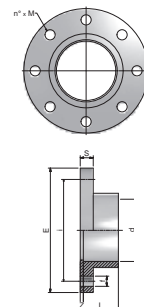

**PSABF**

**ABS Flanges Imperial**  
Full Face Flange Drilled to BS 4504 NP10/16 Plain

Nominal size (d)	Code	L	S	i	f	Z	E	n° x M	PN	Price each
¾"	AFAFNA0250	19	12	75	14	4.5	105	4 x M12	15	£14.52
1"	AFAFNA0320	22	14	85	14	4.5	115	4 x M12	15	£17.44
1¼"	AFAFNA0400	26	15	100	18	4.5	142	4 x M16	15	£20.37
1½"	AFAFNA0500	32	16	110	18	4.5	152	4 x M16	15	£24.70
2"	AFAFNA0630	38	20	125	18	5	165	4 x M16	15	£27.77
2½"	AFAFNA0750	44	19	145	18	6	185	4 x M16	15	£44.36
3"	AFAFNA0900	51	22	160	18	7	200	8 x M16	15	£52.22
4"	AFAFNA1100	63	23	180	18	8	220	8 x M16	15	£66.35

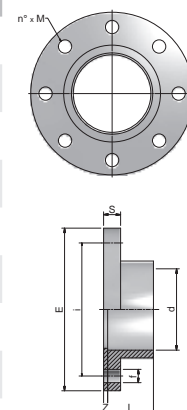

**PSABF**

**ABS Flanges Imperial**

Blanking Flange Drilled to BS4504 NP10/16

Nominal size (d)	Code	DN	S	i	f	E	n° x M	PN	Price each
2"	<b>AFIFCI0630</b>	50	18	125	18	165	4 x M16	63	£75.76
3"	<b>AFIFCI0900</b>	75	20	160	18	200	8 x M16	90	£134.23
4"	<b>AFIFCI1100</b>	100	22	180	18	220	8 x M16	110	£184.22
6"	<b>AFIFCI1600</b>	150	28	240	22	285	8 x M20		£478.79

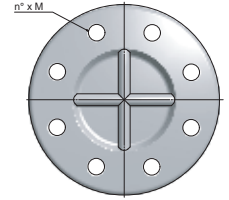
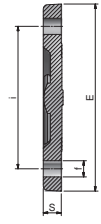



# ABS Adaptor Fittings Imperial

**PSABF**

**ABS Adaptor Fittings Imperial**  
Socket Plain/BSP Female Threaded

Nominal size (d)	RP	Code	L1	L2	CH	Z	E	PN	Price each
1/2"	1/2"	<b>AFCMAC0200</b>	17	15	30	4	28	15	£8.03
3/4"	3/4"	<b>AFCMAC0250</b>	20	16,3	36	6	34	15	£8.91
1"	1"	<b>AFCMAC0320</b>	23	19,8	46	6	42	15	£11.12
1 1/4"	1 1/4"	<b>AFCMAC0400</b>	27	21,4	55	7	51	15	£17.38
1 1/2"	1 1/2"	<b>AFCMAC0500</b>	32	21,4	65	7	61	15	£20.31
2"	2"	<b>AFCMAC0630</b>	38	28	75	6	75	15	£26.73
3"	3"	<b>AFCMAC0900</b>	52	33	110	7	106	15	£73.07

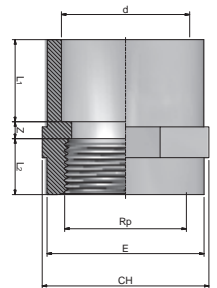

**PSABF**

**ABS Adaptor Fittings Imperial**  
Socket Plain/BSP Female Threaded with Stainless Steel Reinforcing Ring

Nominal size (d)	G	Code	L1	L2	Z	E	Price each
1/2"	BSPT	<b>AFRMER0200</b>	17	15	4	28	£10.09
3/4"	BSPF	<b>AFRMER0250</b>	20	16	6	34	£10.90
1"	BSPF	<b>AFRMER0320</b>	23	19	6	42	£12.91
1 1/4"	BSPF	<b>AFRMER0400</b>	27	21	8	51	£18.79
1 1/2"	BSPF	<b>AFRMER0500</b>	32	21	13	61	£22.36
2"	BSPF	<b>AFRMER0630</b>	39	26	15	89	£27.54

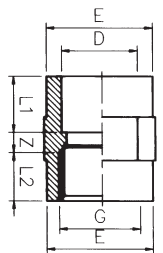

**PSABF**

**ABS Adaptor Fittings Imperial**  
Adaptor Plain Male Spigot/BSP Female Threaded

Nominal size (d)	Rp	Code	L1	L2	CH	H	PN	Price each
1/2"	1/2"	<b>AFCAFC0200</b>	17	15	30	40	15	£5.60
3/4"	3/4"	<b>AFCAFC0250</b>	20	16.3	36	45	15	£6.79
1"	1"	<b>AFCAFC0320</b>	23	19.1	46	51	15	£9.42
1 1/4"	1 1/4"	<b>AFCAFC0400</b>	27	21.4	55	58	15	£11.95
1 1/2"	1 1/2"	<b>AFCAFC0500</b>	32	21.4	65	64	15	£16.25
2"	2"	<b>AFCAFC0630</b>	39	26	75	75	15	£22.69

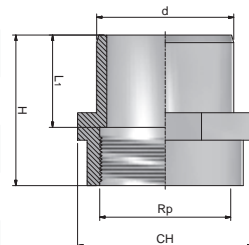

## PSABF

### ABS Adaptor Fittings Imperial

Adaptor Plain Male Spigot/BSP Female Threaded with Stainless Steel Reinforcing Ring

Nominal size (d)	G	Code	L1	L2	E	Z	Price each
½"	BSPF	<b>AFRAER0200</b>	17	15	28	24	£9.05
¾"	BSPF	<b>AFRAER0250</b>	20	16	34	27	£9.09
1"	BSPF	<b>AFRAER0320</b>	23	19	42	30	£11.42
1¼"	BSPF	<b>AFRAER0400</b>	27	21	51	36	£14.21
1½"	BSPF	<b>AFRAER0500</b>	32	21	58	41	£18.19
2"	BSPF	<b>AFRAER0630</b>	39	25	72	48	£24.07

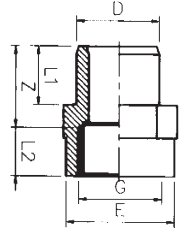

## PSABF

### ABS Adaptor Fittings Imperial

Composite Union Plain/BSP Female Brass Threaded with Plastic Nut

Nominal size (d)	Rp	Code	L1	L2	CH	F	E	H	PN	Price each
½"	½"	<b>AFCPFC0200</b>	16	14	30	1"	43	47	15	£44.12
¾"	¾"	<b>AFCPFC0250</b>	19	16	36	1¼"	54	52	15	£59.14
1"	1"	<b>AFCPFC0320</b>	22	19	46	1½"	60	58	15	£76.08
1¼"	1¼"	<b>AFCPFC0400</b>	27	23	55	2"	75	65	15	£119.54
1½"	1½"	<b>AFCPFC0500</b>	31	23	65	2¼"	81	71	15	£173.74
2"	2"	<b>AFCPFC0630</b>	38	23	80	2¾"	99	85	15	£221.74

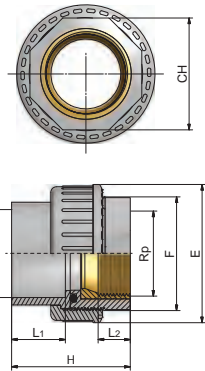

## PSABF

### ABS Adaptor Fittings Imperial

Composite Union Plain/BSP Female Brass Threaded

Nominal size (d)	RP	Code	L1	L2	CH1	CH2	Z1	Z2	H	PN	Price each
½"	½"	<b>AFCBFC0200</b>	16	12	26	44	3	9	40	15	£45.02
¾"	¾"	<b>AFCBFC0250</b>	19	13	32	46	3	9	44	15	£60.35
1"	1"	<b>AFCBFC0320</b>	22	16	38	55	3	10	51	15	£81.43
1¼"	1¼"	<b>AFCBFC0400</b>	27	18	47	65	3	11	59	15	£127.96
1½"	1½"	<b>AFCBFC0500</b>	31	18	54	72	4	11	64	15	£177.29
2"	2"	<b>AFCBFC0630</b>	38	22	66	88	4	12	76	15	£237.38
2½"	2½"	<b>AFCBFC0750</b>	44	24	82	108	4	12	84	15	£466.92
3"	3"	<b>AFCBFC0900</b>	51	31	95	121	5	13	100	15	£518.04

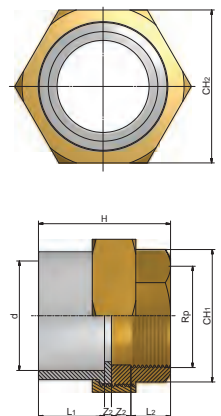

## PSABF

### ABS Adaptor Fittings Imperial

Composite Union Plain/BSP Male Brass Threaded with Plastic Nut

Nominal size (d)	G	Code	L1	L2	CH	F	E	H	PN	Price each
1/2"	1/2"	AFCPMC0200	17	13	30	1"	43	61	15	£47.73
3/4"	3/4"	AFCPMC0250	19	14	36	1 1/4"	54	68	15	£61.00
1"	1"	AFCPMC0320	23	18	46	1 1/2"	60	77	15	£79.74
1 1/4"	1 1/4"	AFCPMC0400	27	21	55	2"	75	87	15	£124.94
1 1/2"	1 1/2"	AFCPMC0500	37	21	65	2 1/4"	81	95	15	£151.63
2"	2"	AFCPMC0630	41	21	80	2 3/4"	99	108	15	£232.19

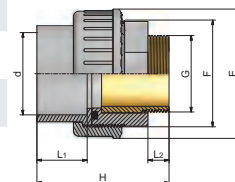
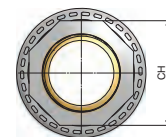

## PSABF

### ABS Adaptor Fittings Imperial

Composite Union Plain/BSP Taper Male Brass Threaded

Nominal size (d)	G	Code	L1	L2	CH1	CH2	Z1	Z2	H	PN	Price each
1/2"	1/2"	AFCBMC0200	16	13.2	25	44	3	19.8	52	15	£51.11
3/4"	3/4"	AFCBMC0250	19	14.5	31	46	3	23.5	60	15	£65.31
1"	1"	AFCBMC0320	22	16.8	38	55	3	24.2	66	15	£85.36
1 1/4"	1 1/4"	AFCBMC0400	27	21	47	65	3	28	79	15	£133.75
1 1/2"	1 1/2"	AFCBMC0500	31	21	53	72	4	29	85	15	£162.31
2"	2"	AFCBMC0630	38	23.4	66	88	4	31.6	97	15	£248.55
2 1/2"	2 1/2"	AFCBMC0750	44	26.7	81	108	4	39.3	114	15	£475.22
3"	3"	AFCBMC0900	51	27.2	95	121	5	42.8	126	15	£618.92

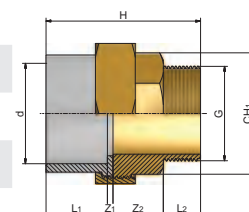
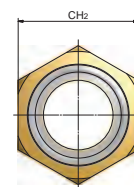

## PSABF

### ABS Adaptor Fittings Imperial

Elbow 90° Plain/BSP Female Threaded

Nominal size (d)	RP	Code	L1	L2	Z1	Z2	E	PN	Price each
1/2"	1/2"	AFCGOC0200	17	15	11	13	28	15	£10.10
3/4"	3/4"	AFCGOC0250	20	16.3	14	17	34	15	£10.70
1"	1"	AFCGOC0320	23	19.1	17	21	42	15	£13.88
1 1/4"	1 1/4"	AFCGOC0400	27	21.4	21	27	51	15	£28.30
1 1/2"	1 1/2"	AFCGOC0500	32	21.4	26	37	61	15	£31.66
2"	2"	AFCGOC0630	39	26	33	46	75	15	£44.80
3"	3"	AFCGOC0900	52	33.3	47	65	106	15	£71.73

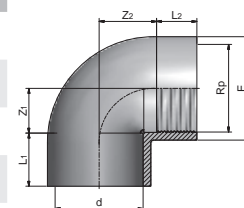

## PSABF

### ABS Adaptor Fittings Imperial

Elbow 90° Plain/BSP Female Threaded with Stainless Steel Reinforcing Ring

Nominal size (d)	Code	L1	L2	Z1	Z2	E	Price each
½"	<b>AFRGER0200</b>	17	15	11	12	28	£11.79
¾"	<b>AFRGER0250</b>	20	16	14	17	34	£12.42
1"	<b>AFRGER0320</b>	23	19	17	20	42	£15.16
1¼"	<b>AFRGER0400</b>	27	21	21	27	51	£27.89
1½"	<b>AFRGER0500</b>	32	21	26	37	61	£31.17
2"	<b>AFRGER0630</b>	39	26	33	46	75	£42.58

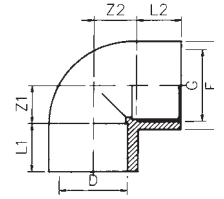

## PSABF

### ABS Adaptor Fittings Imperial

Tee 90° Plain/BSP Female Threaded

Nominal size (d)	RP	Code	L1	L2	Z1	Z2	E	PN	Price each
½"	½"	<b>AFCTIC0200</b>	17	15	11	13	28	15	£10.79
¾"	¾"	<b>AFCTIC0250</b>	19	16.3	14	17	34	15	£11.95
1"	1"	<b>AFCTIC0320</b>	23	19.1	17	21	42	15	£14.45
1¼"	1¼"	<b>AFCTIC0400</b>	27	21.4	21	27	51	15	£30.31
1½"	1½"	<b>AFCTIC0500</b>	32	21.4	26	37	61	15	£33.37
2"	2"	<b>AFCTIC0630</b>	39	26	33	46	75	15	£46.95
3"	3"	<b>AFCTIC0900</b>	52	33.3	47	65	106	15	£92.11

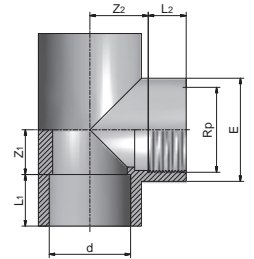

## PSABF

### ABS Adaptor Fittings Imperial

Tee 90° Plain/BSP Female Threaded Branch with Stainless Steel Reinforcing Ring

Nominal size (d)	Code	L1	L2	Z1	Z2	E	Price each
½"	<b>AFRTER0200</b>	17	15	11	12	28	£12.27
¾"	<b>AFRTER0250</b>	20	16	14	17	34	£13.37
1"	<b>AFRTER0320</b>	23	19	17	20	42	£15.55
1¼"	<b>AFRTER0400</b>	27	21	21	27	51	£29.37
1½"	<b>AFRTER0500</b>	32	21	26	37	61	£32.39
2"	<b>AFRTER0630</b>	39	26	33	46	75	£44.04

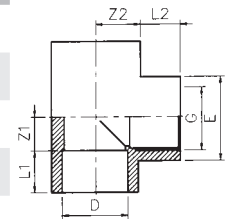

## PSABF

### ABS Adaptor Fittings Imperial Reducing Bush Plain/BSP Female Threaded

Nominal size	d	Code	Rp	L Min	Z Max	PN	Price each
1/2" x 3/8"	1/2"	AFCRCC020A	3/8"	15	4	15	£5.90
3/4" x 1/2"	3/4"	AFCRCC025B	1/2"	17	6	15	£6.79
1" x 3/4"	1"	AFCRCC032C	3/4"	16.3	5.7	15	£9.01

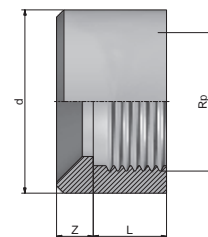

## PSABF

### ABS Adaptor Fittings Imperial Adaptor Female Plain/BSP Male Threaded

Nominal size (d)	d1	Code	L	L1	L2	CH	G	H	PN	Price each
1/2"	3/4"	AFCAMC0200	17	20	15	30	1/2"	46	15	£4.76
3/4"	1"	AFCAMC0250	20	23	16.3	36	3/4"	50	15	£6.21
1"	1 1/4"	AFCAMC0320	23	27	19.1	46	1"	57	15	£8.55
1 1/4"	1 1/2"	AFCAMC0400	27	32	21.4	55	1 1/4"	67	15	£11.78
1 1/2"	2"	AFCAMC0500	32	39	21.4	65	1 1/2"	74	15	£15.32
2"	2 1/2"	AFCAMC0630	39	44	25.7	80	2"	84	15	£21.95
3"	4"	AFCAMC0900	52	63	33.3	115	3"	113	15	£63.08
4"	5"	AFCAMC1100	63	66	39.3	130	4"	120	15	£84.75

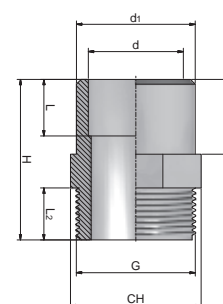

## PSABF

### ABS Adaptor Fittings Imperial Barrel Nipple Plain/BSP Male Taper Threaded

Nominal size (d)	Code	L1	L2	Price each
1/2"	AFCBNC0200	50	17	£5.90
3/4"	AFCBNC0250	56	16	£7.37
1"	AFCBNC0320	63	20	£9.42
1 1/4"	AFCBNC0400	75	24	£12.99
1 1/2"	AFCBNC0500	88	30	£17.78
2"	AFCBNC0630	88	32	£24.53
2 1/2"	AFCBNC0750	106	35	£42.67
3"	AFCBNC0900	128	39	£53.35
4"	AFCBNC1100	153	43	£87.22

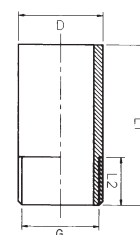

## PSABF

### ABS Adaptor Fittings Imperial

Tank Connector Plain/BSP Male Threaded EPDM Gasket

Nominal size (d)	Code	d	L	F	Price each
1/2"	AFCTCC0200	42	77	38	£18.12
3/4"	AFCTCC0250	42	77	42	£21.75
1"	AFCTCC0320	55	103	55	£54.77
1 1/4"	AFCTCC0400	70	121	65	£87.24
1 1/2"	AFCTCC0500	73	128	72	£103.49
2"	AFCTCC0630	85	154	93	£119.20
2 1/2"	AFCTCC0750	88	164	106	£156.66
3"	AFCTCC0900	112	202	125	£204.52
4"	AFCTCC1100	130	230	154	£237.62

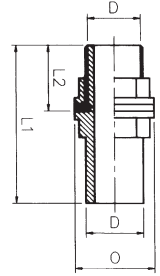

# ABS Threaded Fittings Imperial

**PSABF**

**ABS Threaded Fittings Imperial**  
Socket BSP Female Threaded

Nominal size	G	Code	L	Z	E	Price each
1/2"	BSPF	<b>AFFMAF0200</b>	15	7	27	£10.70
3/4"	BSPF	<b>AFFMAF0250</b>	16	7	33	£11.95
1"	BSPF	<b>AFFMAF0320</b>	19	8	41	£15.06
1 1/4"	BSPF	<b>AFFMAF0400</b>	21	8	50	£20.56
1 1/2"	BSPF	<b>AFFMAF0500</b>	21	8	61	£23.17
2"	BSPF	<b>AFFMAF0630</b>	26	8	75	£29.15

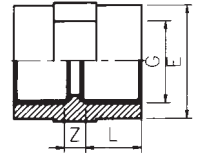

**PSABF**

**ABS Threaded Fittings Imperial**  
Elbow 90° BSP Female Threaded

Nominal size	G	Code	L1/L2	Z1/Z2	E	Price each
1/2"	BSPF	<b>AFFGOF0200</b>	15	12	28	£10.47
3/4"	BSPF	<b>AFFGOF0250</b>	16	17	34	£10.70
1"	BSPF	<b>AFFGOF0320</b>	19	20	42	£14.05
1 1/4"	BSPF	<b>AFFGOF0400</b>	21	26	51	£21.88
1 1/2"	BSPF	<b>AFFGOF0500</b>	21	36	62	£34.28
2"	BSPF	<b>AFFGOF0630</b>	26	45	77	£41.87

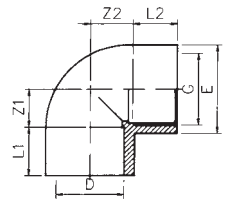

**PSABF**

**ABS Threaded Fittings Imperial**  
Tee 90° BSP Female Threaded

Nominal size	G	Code	L1/L2	Z1/Z2	E	Price each
1/2"	BSPF	<b>AFFTIF0200</b>	15	12	28	£10.79
3/4"	BSPF	<b>AFFTIF0250</b>	16	17	34	£11.95
1"	BSPF	<b>AFFTIF0320</b>	19	20	42	£16.33
1 1/4"	BSPF	<b>AFFTIF0400</b>	21	26	51	£32.88
1 1/2"	BSPF	<b>AFFTIF0500</b>	21	36	62	£35.62
2"	BSPF	<b>AFFTIF0630</b>	26	45	77	£61.28

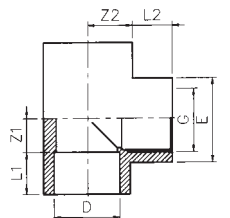

## PSABF

### ABS Threaded Fittings Imperial Cap BSP Female Threaded

Nominal size	G	Code	L	H	E	Price each
1/2"	BSPF	<b>AFFCAF0200</b>	15	21	28	£8.81
3/4"	BSPF	<b>AFFCAF0250</b>	16	23	34	£12.34
1"	BSPF	<b>AFFCAF0320</b>	19	26	42	£13.08
1 1/4"	BSPF	<b>AFFCAF0400</b>	21	29	51	£14.15
1 1/2"	BSPF	<b>AFFCAF0500</b>	21	32	61	£18.26
2"	BSPF	<b>AFFCAF0630</b>	26	37	75	£23.10
3"	BSPF	<b>AFFCAF0900</b>	33	53	103	£79.99

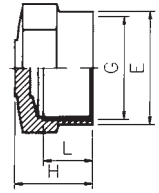

## PSABF

### ABS Threaded Fittings Imperial Plug BSP Male Threaded

Nominal size	G	Code	L	H	O	Price each
1/2"	BSPM	<b>AFFTAF0200</b>	15	29	24	£6.21
3/4"	BSPM	<b>AFFTAF0250</b>	16	30	30	£7.63
1"	BSPM	<b>AFFTAF0320</b>	19	33	36	£9.13
1 1/4"	BSPM	<b>AFFTAF0400</b>	21	39	46	£12.65
1 1/2"	BSPM	<b>AFFTAF0500</b>	21	39	50	£15.32
2"	BSPM	<b>AFFTAF0630</b>	26	43	65	£17.37

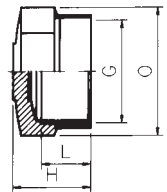



## PSABF

### ABS Threaded Fittings Imperial Reducing Bush BSP Male Threaded/BSP Female Threaded

Nominal size	Code	L1	L2	Z	O	Price each
3/4" x 1/2"	<b>AFFRCF025B</b>	16	15	13	30	£9.05
1" x 3/4"	<b>AFFRCF032C</b>	19	16	14	36	£11.01
1 1/4" x 1"	<b>AFFRCF040D</b>	21	19	16	46	£28.24
1 1/2" x 1 1/4"	<b>AFFRCF050E</b>	21	21	14	55	£28.75
2" x 1 1/2"	<b>AFFRCF063F</b>	25	21	18	65	£32.08
2 1/2" x 2"	<b>AFFRCF075G</b>	30	25	20	80	£37.46
3" x 2 1/2"	<b>AFFRCF090H</b>	33	30	20	95	£63.04
4" x 3"	<b>AFFRCF110I</b>	39	33	24	120	£66.18

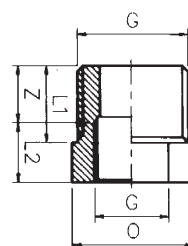

## PSABF

### ABS Threaded Fittings Imperial Barrel Nipple BSP Male Taper Threaded

Nominal size	G	Code	L	H	Price each
1/2"	BSPT	<b>AFFBAF0200</b>	16	50	£6.49
3/4"	BSPT	<b>AFFBAF0250</b>	19	56	£7.63
1"	BSPT	<b>AFFBAF0320</b>	21	62	£10.21
1 1/4"	BSPT	<b>AFFBAF0400</b>	24	75	£13.08
1 1/2"	BSPT	<b>AFFBAF0500</b>	32	87	£14.29
2"	BSPT	<b>AFFBAF0630</b>	29	87	£18.26
2 1/2"	BSPT	<b>AFFBAF0750</b>	30	105	£39.87
3"	BSPT	<b>AFFBAF0900</b>	37	128	£42.23
4"	BSPT	<b>AFFBAF1100</b>	42	156	£73.69

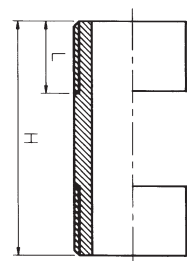

## PSABF

### ABS Threaded Fittings Imperial Hexagon Nipple BSP Male Threaded

Nominal size	G	Code	L	H	O	Price each
1/2"	BSPM	<b>AFFNIF0200</b>	15	42	24	£5.45
3/4"	BSPM	<b>AFFNIF0250</b>	16	44	30	£7.21
1"	BSPM	<b>AFFNIF0320</b>	19	50	36	£9.13
1 1/4"	BSPM	<b>AFFNIF0400</b>	21	58	46	£12.67
1 1/2"	BSPM	<b>AFFNIF0500</b>	21	58	50	£15.01
2"	BSPM	<b>AFFNIF0630</b>	26	66	65	£18.12

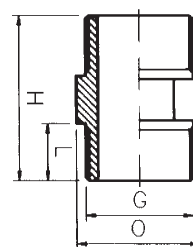

**PSABF**

**ABS Threaded Fittings Imperial**  
Backnut BSP Female Threaded

Nominal Size (Rp)	Code	CH	H	E	PN	Price each
1/2"	<b>AFFNUF0200</b>	38	13	28	15	£4.49
3/4"	<b>AFFNUF0250</b>	43	14	33	15	£4.99
1"	<b>AFFNUF0320</b>	56	16	46	15	£8.47
1 1/4"	<b>AFFNUF0400</b>	65	18	50	15	£17.74
1 1/2"	<b>AFFNUF0500</b>	72	19	60	15	£20.17
2"	<b>AFFNUF0630</b>	94	21	80	15	£22.20
2 1/2"	<b>AFFNUF0750</b>	105	23	95	15	£26.14
3"	<b>AFFNUF0900</b>	125	27	110	15	£29.47
4"	<b>AFFNUF1100</b>	154	31	140	15	£38.90

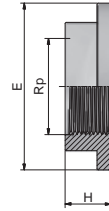
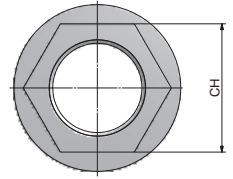

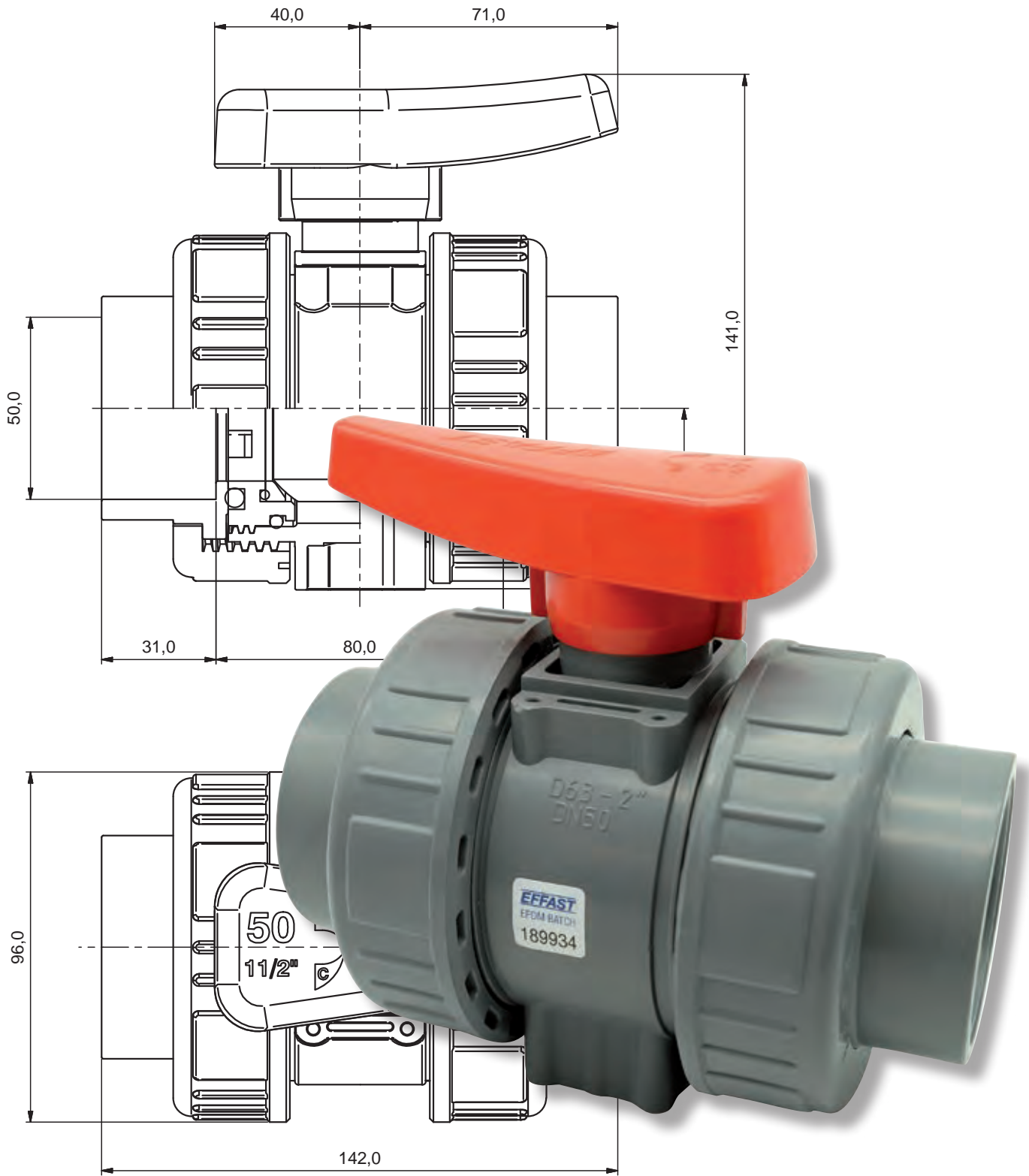

# ABS Industrial Manual Ball Valves

## Technical Features

- Floating full bore ball locked in place on both sides
- Fully round ball smoothed by special turning machine
- Solvent welded sockets or threaded sockets
- PTFE ball seat
- Nominal pressure (PN): 16 bar – 232 psi at 20°C
- Handle with combined key for the dismantling of the valve and the tightening of threaded gasket carrier
- Valves individually tested
- The valves are manufactured with a ABS fit for contact with potable water in accordance with regulations in U.K., Italy, France, Germany, Holland and Scandinavian countries.

## Torque: ABS Ball Valves

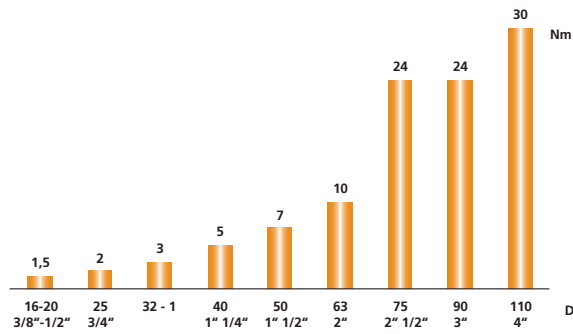

## Pressure Loss: ABS Ball Valves

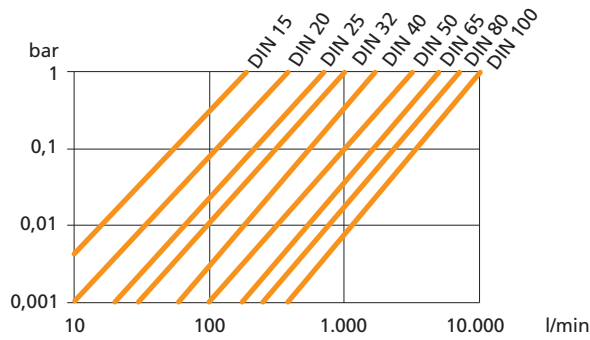

## Maximum Working Pressure: ABS Ball Valves

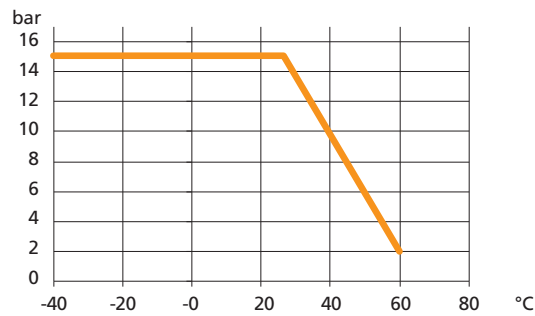

## Flow Rate: ABS Ball Valves

d	16/20	25	32	40	50	63	75	90	110
DN	15	20	25	32	40	50	65	80	100
L/m ΔP =1 Bar	190	380	700	1000	1700	3200	5000	7000	10000

## ABS Industrial Manual Ball Valves

Marine approval  
CE Approval



- 
- 
3. Ergonomic handle with integrated tool for removing of union bushings and adjust the ball seat carrier

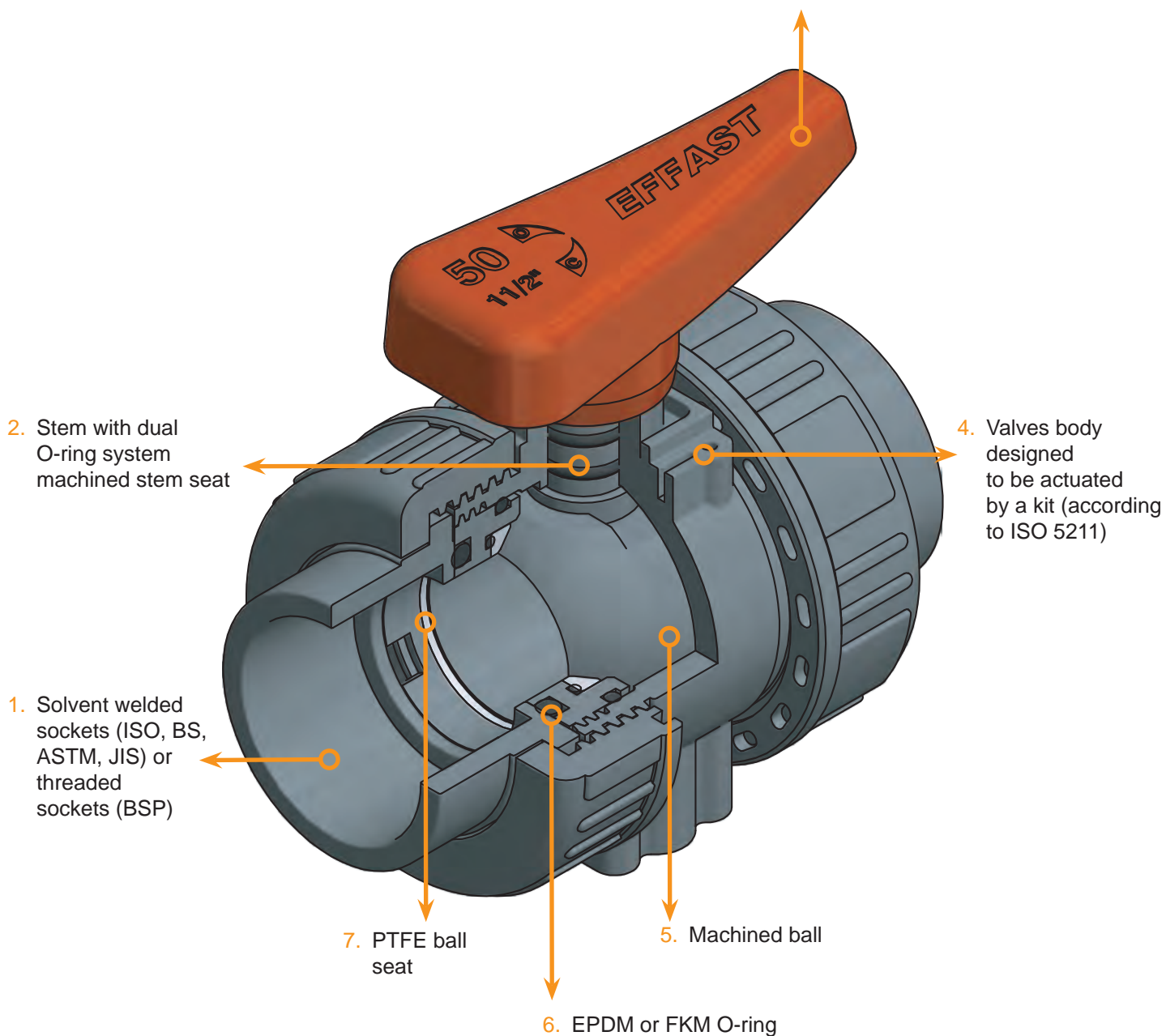

# ABS Industrial Manual Ball Valves

**PSABV**

**ABS Industrial Manual Ball Valves**  
Industrial Double Union Ball Valve Plain Sockets EPDM Seals

Nominal Size (d)	Code	DN	L	Z	C1	C2	H1	H2	E	K	Ø x h	PN	Price each
3/8"	ABA22A0160	15	14.5	51	22	42	50	25	49	18	M4 x 8	16	£53.45
1/2"	ABA22A0200	15	16	48	22	42	50	25	49	18	M4 x 8	16	£54.46
3/4"	ABA22A0250	20	19	54	24	49	58	31	60	21.5	M4 x 8	16	£66.71
1"	ABA22A0320	25	22	62	26	59	69	35	69	28	M4 x 8	16	£79.20
1 1/4"	ABA22A0400	32	26	69	32	65	76	41	80	30	M5 x 10	16	£101.66
1 1/2"	ABA22A0500	40	31	81	40	71	92	50	96	38	M6 x 14	16	£130.17
2"	ABA22A0630	50	39	94	45	79	104	62	116	45	M6 x 14	16	£161.22
2 1/2"	ABA22A0750	65	44	141	84.5	84.5	145	84	167	-	-	16	£353.52
3"	ABA22A0900	80	51	140	84.5	84.5	145	84	167	-	-	16	£453.43
4"	ABA22A1100	100	61	162	102	102	170	105	209	-	-	16	£632.03

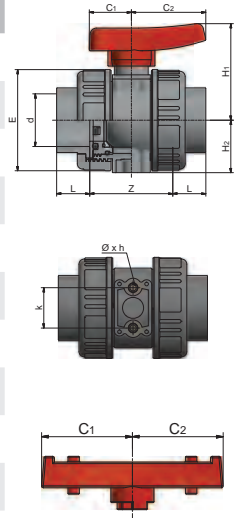

**PSABV**

**ABS Industrial Manual Ball Valves**  
Industrial Double Union Ball Valve Plain Sockets FKM Seals

Nominal Size (d)	Code	DN	L	Z	C1	C2	H1	H2	E	K	Ø x h	PN	Price each
3/8"	ABA23A0160	15	14.5	51	22	42	50	25	49	18	M4 x 8	16	£62.60
1/2"	ABA23A0200	15	16	48	22	42	50	25	49	18	M4 x 8	16	£71.01
3/4"	ABA23A0250	20	19	54	24	49	58	31	60	21.5	M4 x 8	16	£85.09
1"	ABA23A0320	25	22	62	26	59	69	35	69	28	M4 x 8	16	£103.39
1 1/4"	ABA23A0400	32	26	69	32	65	76	41	80	30	M5 x 10	16	£111.56
1 1/2"	ABA23A0500	40	31	81	40	71	92	50	96	38	M6 x 14	16	£148.71
2"	ABA23A0630	50	39	94	45	79	104	62	116	45	M6 x 14	16	£220.35
2 1/2"	ABA23A0750	65	44	141	84.5	84.5	145	84	167	-	-	16	£482.61
3"	ABA23A0900	80	51	140	84.5	84.5	145	84	167	-	-	16	£578.60
4"	ABA23A1100	100	61	162	102	102	170	105	209	-	-	16	£823.87

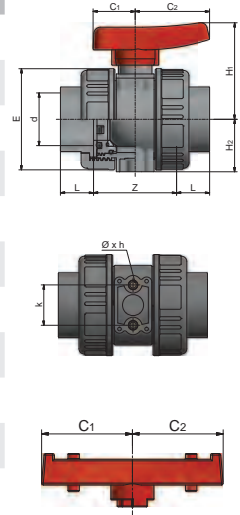

**PSAQU**

**ABS Pressure Relief**  
Pressure Relief Valve (operates between 0.5 and 6.5 bar) EPDM Seals

Nominal Size	Code	Price each
1/2" - 20mm	ABAPRV0200	£680.48
3/4" - 25mm	ABAPRV0250	£735.74
1" - 32mm	ABAPRV0320	£794.45
1 1/4" - 40mm	ABAPRV0400	£931.61
1 1/2" - 50mm	ABAPRV0500	£1,079.40
2" - 63mm	ABAPRV0630	£1,235.58



ABS - Valves

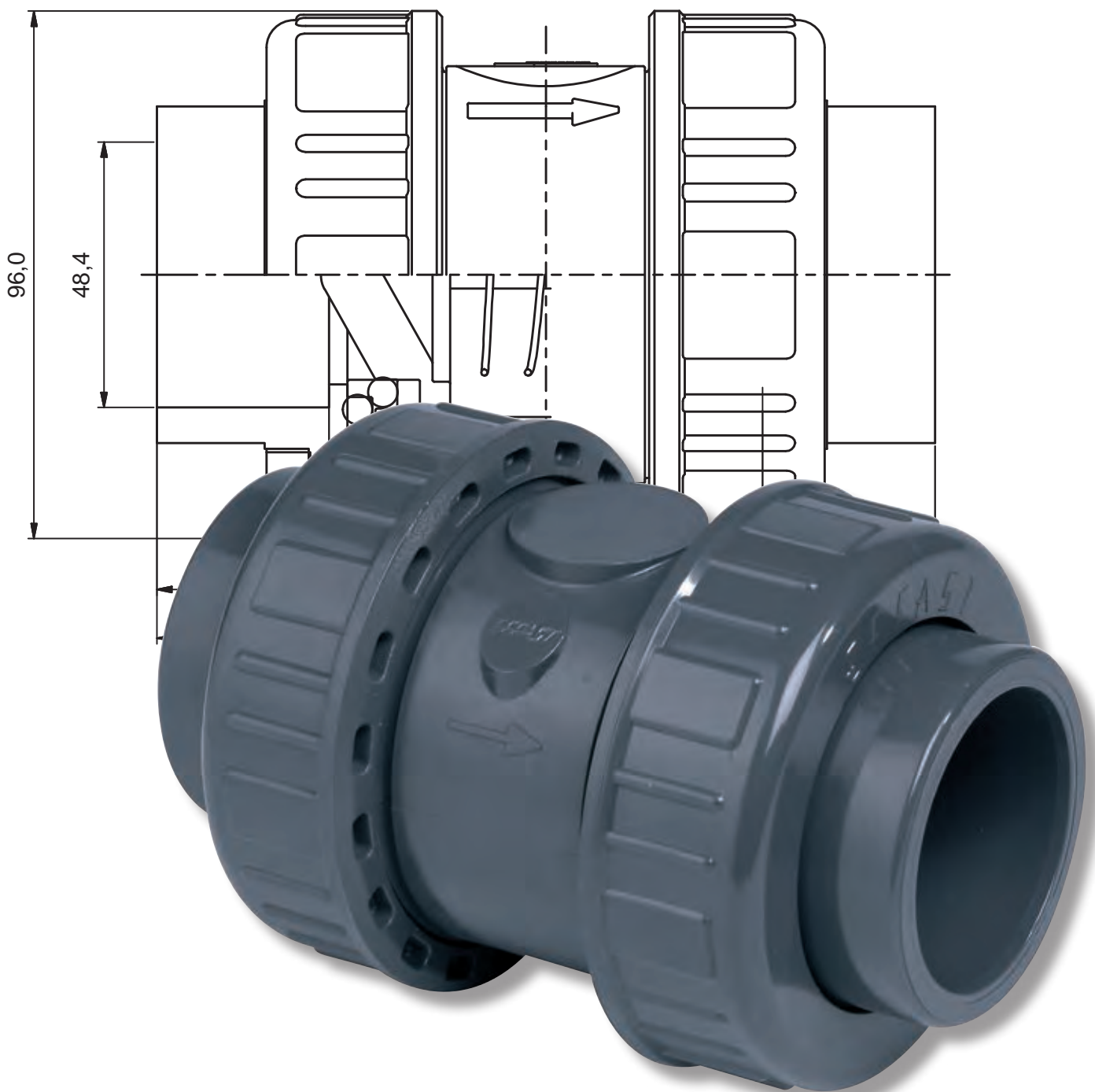

## ABS Auxiliary and Check Valves

---

## Technical Features

- Stainless steel spring or PTFE coated
- Nominal pressure (PN): 16 bar – 232 psi at 20°C
- May be used either vertically and horizontally
- Solvent welded sockets or threaded sockets
- The valves are manufactured with a ABS fit for contact with potable water in accordance with regulations in U.K., Italy, France, Germany, Holland and Scandinavian countries.

## Pressure Loss: ABS Check Valves

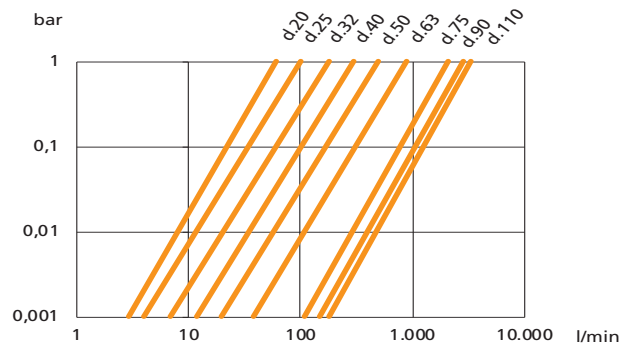

## Maximum Working Pressure: ABS Check Valves

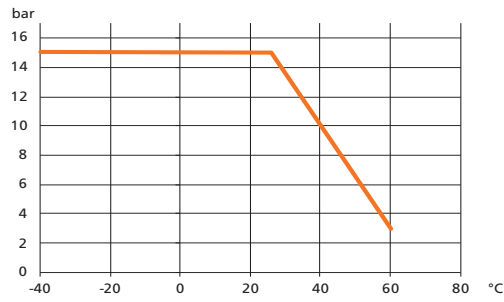

## Flow Rate: ABS Check Valves

d	20	25	32	40	50	63	75	90	110
<b>G</b>	1/2"	3/4"	1"	1"1/4	1"1/2	2"	2"1/2	3"	4"
<b>DN</b>	15	20	25	32	40	50	65	80	100
<b>Bar</b>	0,012	0,01	0,01	0,01	0,008	0,008	0,006	0,006	0,006



# ABS Check Valve

CE Approval

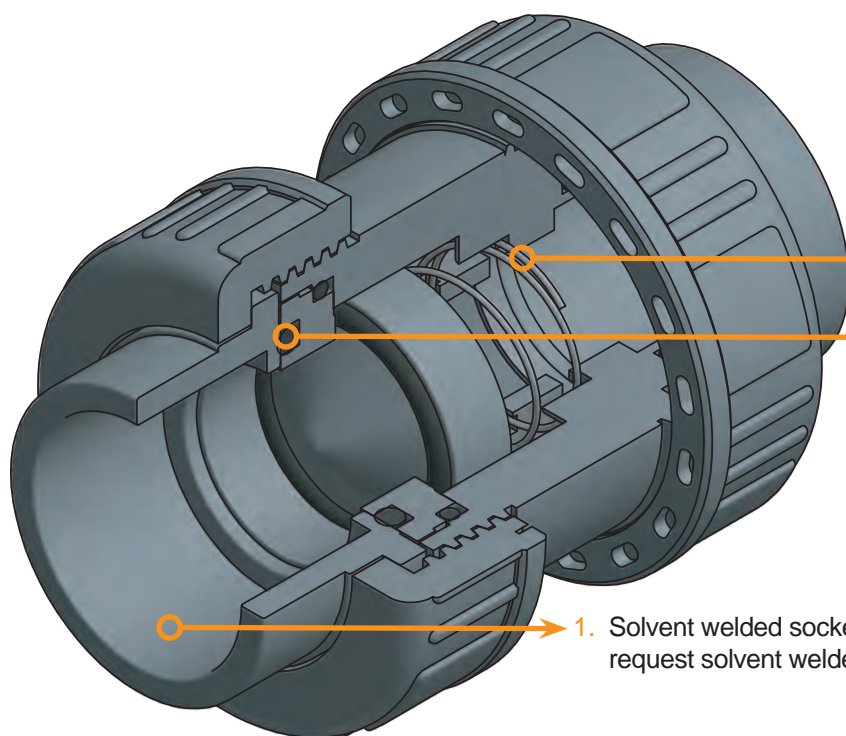

- 3. Stainless steel spring or PTFE coated spring
- 2. EPDM or FKM certified O-ring

- 1. Solvent welded socket (ISO, BS) or threaded socket (BSP). Available on request solvent welded socket (ASTM, JIS) and threaded socket (NPT)

# ABS Air Release Valve

Marine approval  
CE Approval

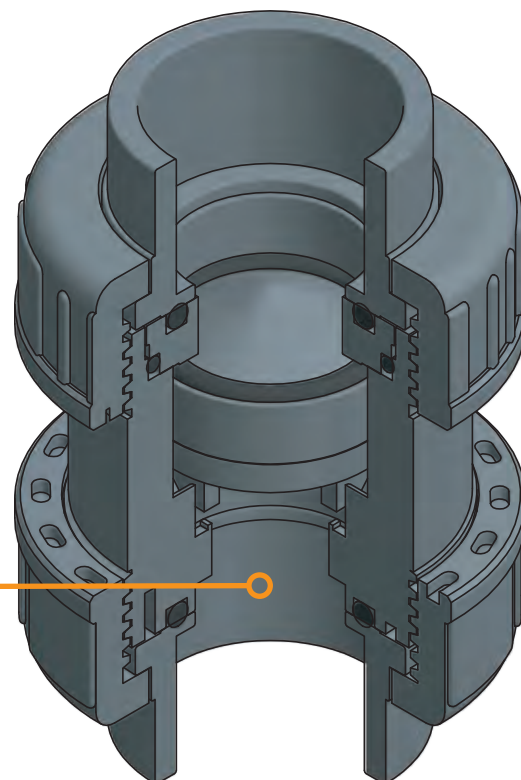

- 1. Solvent welded sockets (ISO, BS) or threaded sockets (BSP)

# ABS Check Valves Imperial

**PSABV**
**ABS Check Valves Imperial**

Check Valve Plain Sockets Stainless Steel Spring EPDM Seals

Nominal Size (d)	Code	DN	L	Z	E	PN	Price each
3/8"	<b>ABA30A0160</b>	15	14.5	51	49	16	£49.42
1/2"	<b>ABA30A0200</b>	15	16	48	49	15	£51.20
3/4"	<b>ABA30A0250</b>	20	19	54	60	15	£64.42
1"	<b>ABA30A0320</b>	25	22	62	69	15	£65.70
1 1/4"	<b>ABA30A0400</b>	32	26	69	80	15	£77.45
1 1/2"	<b>ABA30A0500</b>	40	31	81	96	15	£112.40
2"	<b>ABA30A0630</b>	50	39	94	116	15	£148.97

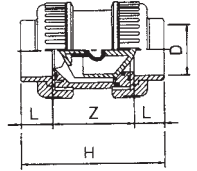
**PSABV**
**ABS Check Valves Imperial**

Check Valve Plain Sockets PTFE Coated Spring EPDM Seals

Nominal Size	Code	L	Z	H	PN	Price each
3/8"	<b>ABA31A0160</b>	16	46	78	16	£63.61
1/2"	<b>ABA31A0200</b>	17	46	78	16	£79.68
3/4"	<b>ABA31A0250</b>	20	52	90	16	£84.30
1"	<b>ABA31A0320</b>	23	60	104	16	£88.05
1 1/4"	<b>ABA31A0400</b>	27	68	120	16	£90.93
1 1/2"	<b>ABA31A0500</b>	31	78	140	16	£121.20
2"	<b>ABA31A0630</b>	38	93	169	16	£138.76

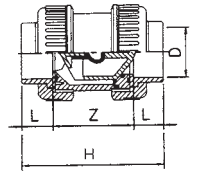

# ABS Air Release Valves

**PSABV**

**ABS Air Release Valves**  
Air Release Valve Plain Sockets with EPDM Seals

Nominal Size (d)	Code	DN	L	Z	E	PN	Price each
3/8"	<b>ABA33A0160</b>	15	14.5	51	49	16	£45.31
1/2"	<b>ABA33A0200</b>	15	16	48	49	16	£49.96
3/4"	<b>ABA33A0250</b>	20	19	54	60	16	£62.92
1"	<b>ABA33A0320</b>	25	22	62	69	16	£67.40
1 1/4"	<b>ABA33A0400</b>	32	26	69	80	16	£70.09
1 1/2"	<b>ABA33A0500</b>	40	31	81	96	16	£108.15
2"	<b>ABA33A0630</b>	50	39	94	116	16	£141.90

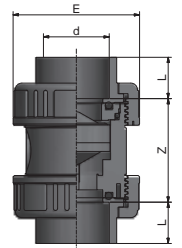

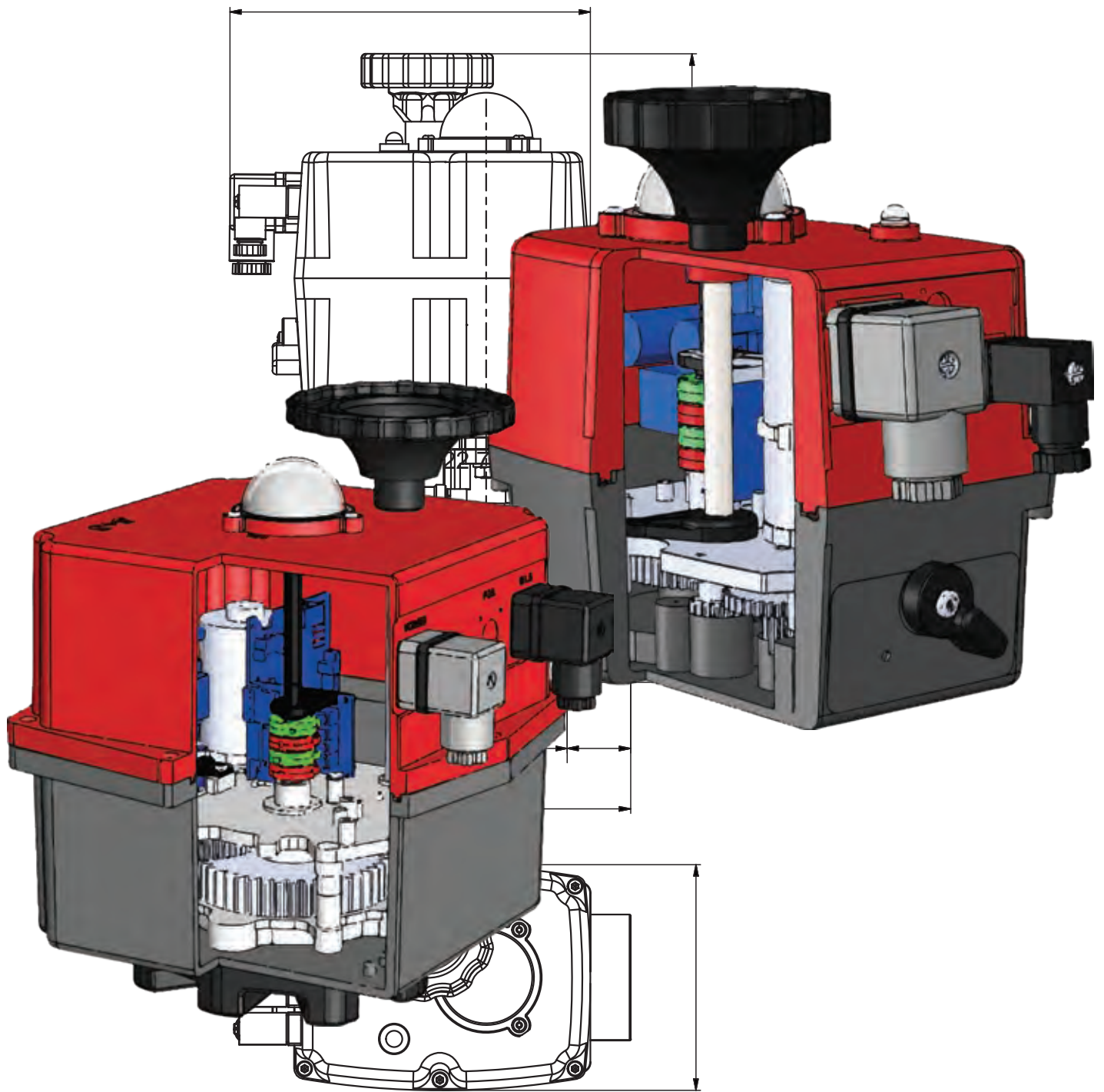

# Actuated Valves

## Actuation valve and control

### Pneumatic Actuation

Pneumatic actuators are air operated mechanical devices which convert compressed air pressure into mechanical force to operate the valve. No leakage ensures zero contamination in surrounding areas. Requires centralised source of compressed air.



- 1 year warranty
- Available in both double acting and spring return
- ATEX EXII2GDcT certification
- Assemblies based on a 6 bar air supply (8 bar max)
- Compliant with Namur & VDI VDE3845
- ISO 5211 and DIN 3337 compliant
- Hard anodized aluminum body and epoxy coated end caps
- Double acting torques from 9 to 3916 Nm at 6 bar
- Single acting torques from 9.5 to 1547.5 Nm at 6 bar

### Accessories

Switchbox and solenoid option available on request

### Electric Actuation

Electric Actuator converts electrical input into kinetic energy to operate the valve. Electric actuators provide precise control and positioning and have low operating costs.



- 3 year / 60,000 cycle warranty (whichever comes first)
- Accepts 24-240VDC/ VAC 50/60Hz (-0/+5%) external power range
- Multi-coloured LED light for continuous status feedback to user
- Brushless motor technology
- All external electric connections via DIN plugs
- Thermostatic anti-condensation 3.5W heater
- Electronic torque limiter
- Dome local high visibility position indicator
- 2 volt free end of travel confirmation switches
- Handwheel operated selectable manual override

### Accessories

Modulating and fail-safe options available

## Construct your requirements in a four stage process

**1** Choose Pneumatic or Electric Actuator

**2** Choose your valve material

**3** Choose your seal material

**4** Choose your valve style

# PVC-u Electrically Actuated Double Union Industrial Ball Valves Imperial

**PSACT**

**PVC-u Electrically Actuated Double Union Industrial Ball Valves Imperial**  
Electrically Actuated On/Off Double Union Industrial Ball Valve – Plain Sockets EPDM Seals

Nominal size	Code	Price each
1/2"	RBA24A0200	£817.39
3/4"	RBA24A0250	£829.99
1"	RBA24A0320	£967.04
1 1/4"	RBA24A0400	£988.87
1 1/2"	RBA24A0500	£1,080.48
2"	RBA24A0630	£1,150.16
2 1/2"	RBA24A0750	£1,777.88
3"	RBA24A0900	£1,980.45
4"	RBA24A1100	£2,210.78

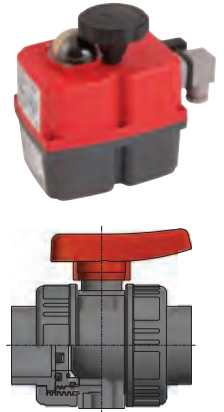

**PSACT**

**PVC-u Electrically Actuated Double Union Industrial Ball Valves Imperial**  
Electrically Actuated On/Off Double Union Industrial Ball Valve – Plain Sockets FKM Seals

Nominal size	Code	Price each
1/2"	RBA25A0200	£829.99
3/4"	RBA25A0250	£838.45
1"	RBA25A0320	£859.53
1 1/4"	RBA25A0400	£880.59
1 1/2"	RBA25A0500	£910.00
2"	RBA25A0630	£943.78
2 1/2"	RBA25A0750	£1,860.09
3"	RBA25A0900	£2,071.00
4"	RBA25A1100	£2,291.50

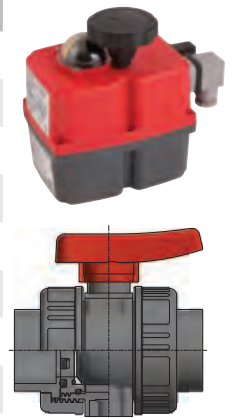

# PVC-u Electrically Actuated Double Union Industrial Ball Valves Metric

**PSACT**

**PVC-u Electrically Actuated Double Union Industrial Ball Valves Metric**  
Electrically Actuated On/Off Double Union Industrial Ball Valve – Plain Sockets EPDM Seals

Nominal size	Code	Price each
20	<b>RBI24I0200</b>	£817.39
25	<b>RBI24I0250</b>	£829.99
32	<b>RBI24I0320</b>	£967.04
40	<b>RBI24I0400</b>	£988.87
50	<b>RBI24I0500</b>	£1,018.10
63	<b>RBI24I0630</b>	£1,049.29
75	<b>RBI24I0750</b>	£1,777.88
90	<b>RBI24I0900</b>	£1,980.45
110	<b>RBI24I1100</b>	£2,210.78

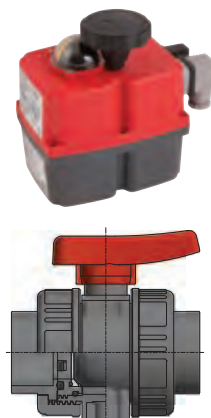

**PSACT**

**PVC-u Electrically Actuated Double Union Industrial Ball Valves Metric**  
Electrically Actuated On/Off Double Union Industrial Ball Valve – Plain Sockets FKM Seals

Nominal size	Code	Price each
20	<b>RBI25I0200</b>	£829.99
25	<b>RBI25I0250</b>	£917.35
32	<b>RBI25I0320</b>	£859.53
40	<b>RBI25I0400</b>	£880.59
50	<b>RBI25I0500</b>	£910.00
63	<b>RBI25I0630</b>	£943.78
75	<b>RBI25I0750</b>	£1,860.09
90	<b>RBI25I0900</b>	£2,071.00
110	<b>RBI25I1100</b>	£2,291.50

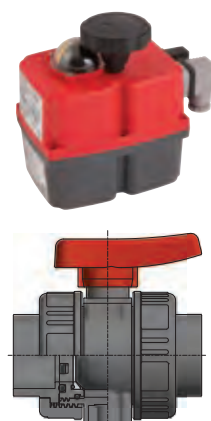



# PVC-u Pneumatically Actuated Double Union Industrial Ball Valves Imperial

**PSACT**
**PVC-u Pneumatically Actuated Double Union Industrial Ball Valves Imperial**

Pneumatic Spring Return Actuated Double Union Industrial Ball Valve – Plain Sockets EPDM Seals

Nominal size	Code	Price each
1/2"	RBA26A0200	£430.79
3/4"	RBA26A0250	£478.50
1"	RBA26A0320	£517.07
1 1/4"	RBA26A0400	£557.17
1 1/2"	RBA26A0500	£579.81
2"	RBA26A0630	£810.17
2 1/2"	RBA26A0750	£1,169.85
3"	RBA26A0900	£1,244.34
4"	RBA26A1100	£1,296.76

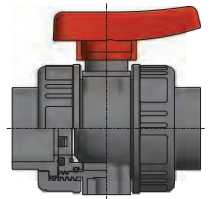
**PSACT**
**PVC-u Pneumatically Actuated Double Union Industrial Ball Valves Imperial**

Pneumatic Spring Return Double Union Industrial Ball Valve – Plain Sockets FKM Seals

Nominal size	Code	Price each
1/2"	RBA27A0200	£437.34
3/4"	RBA27A0250	£446.12
1"	RBA27A0320	£461.45
1 1/4"	RBA27A0400	£498.53
1 1/2"	RBA27A0500	£522.65
2"	RBA27A0630	£555.45
2 1/2"	RBA27A0750	£1,228.33
3"	RBA27A0900	£1,318.61
4"	RBA27A1100	£1,423.07

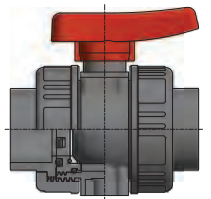



# PVC-u Pneumatically Actuated Double Union Industrial Ball Valves Metric

## PSACT

**PVC-u Pneumatically Actuated Double Union Industrial Ball Valves Metric**  
Pneumatic Spring Return Actuated Double Union Industrial Ball Valve – Plain Sockets EPDM Seals

Nominal size	Code	Price each
20	<b>RBI26I0200</b>	£430.79
25	<b>RBI26I0250</b>	£437.34
32	<b>RBI26I0320</b>	£517.07
40	<b>RBI26I0400</b>	£557.17
50	<b>RBI26I0500</b>	£579.81
63	<b>RBI26I0630</b>	£607.35
75	<b>RBI26I0750</b>	£1,169.85
90	<b>RBI26I0900</b>	£1,244.34
110	<b>RBI26I1100</b>	£1,296.76

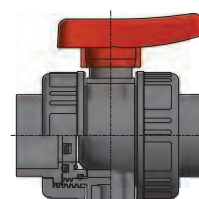

## PSACT

**PVC-u Pneumatically Actuated Double Union Industrial Ball Valves Metric**  
Pneumatic Spring Return Double Union Industrial Ball Valve – Plain Sockets FKM Seals

Nominal size	Code	Price each
20	<b>RBI27I0200</b>	£437.34
25	<b>RBI27I0250</b>	£446.12
32	<b>RBI27I0320</b>	£461.45
40	<b>RBI27I0400</b>	£498.53
50	<b>RBI27I0500</b>	£522.65
63	<b>RBI27I0630</b>	£555.45
75	<b>RBI27I0750</b>	£1,228.33
90	<b>RBI27I0900</b>	£1,318.61
110	<b>RBI27I1100</b>	£1,423.07

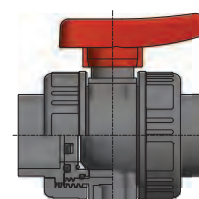

# ABS Electrically Actuated Double Union Industrial Ball Valves Imperial

**PSACT**

**ABS Electrically Actuated Double Union Industrial Ball Valves Imperial**  
Electrically Actuated On/Off Double Union Industrial Ball Valve – Plain Sockets EPDM Seals

Nominal Size (d)	Code	Price each
1/2"	<b>ABA24A0200</b>	£840.05
3/4"	<b>ABA24A0250</b>	£850.82
1"	<b>ABA24A0320</b>	£863.76
1 1/4"	<b>ABA24A0400</b>	£889.65
1 1/2"	<b>ABA24A0500</b>	£915.43
2"	<b>ABA24A0630</b>	£1,053.82
2 1/2"	<b>ABA24A0750</b>	£1,211.90
3"	<b>ABA24A0900</b>	£1,268.21
4"	<b>ABA24A1100</b>	£1,528.36

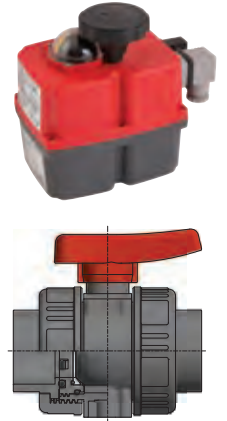

**PSACT**

**ABS Electrically Actuated Double Union Industrial Ball Valves Imperial**  
Electrically Actuated On/Off Double Union Industrial Ball Valve – Plain Sockets FKM Seals

Nominal Size (d)	Code	Price each
1/2"	<b>ABA25A0200</b>	£850.82
3/4"	<b>ABA25A0250</b>	£859.47
1"	<b>ABA25A0320</b>	£885.34
1 1/4"	<b>ABA25A0400</b>	£904.66
1 1/2"	<b>ABA25A0500</b>	£936.95
2"	<b>ABA25A0630</b>	£986.58
2 1/2"	<b>ABA25A0750</b>	£1,932.09
3"	<b>ABA25A0900</b>	£2,147.87
4"	<b>ABA25A1100</b>	£2,377.34

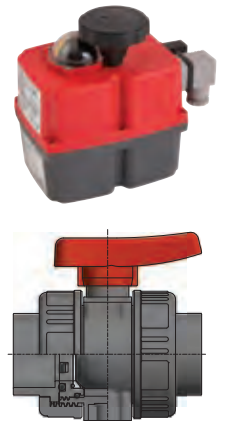

# ABS Pneumatically Actuated Double Union Industrial Ball Valves Imperial

**PSACT**

**ABS Pneumatically Actuated Double Union Industrial Ball Valves Imperial**  
 Pneumatic Spring Return Double Union Industrial Ball Valve – Plain Sockets EPDM Seals

Nominal Size	Code	Price each
1/2"	<b>ABA26A0200</b>	£442.81
3/4"	<b>ABA26A0250</b>	£449.48
1"	<b>ABA26A0320</b>	£467.38
1 1/4"	<b>ABA26A0400</b>	£525.45
1 1/2"	<b>ABA26A0500</b>	£523.93
2"	<b>ABA26A0630</b>	£555.62
2 1/2"	<b>ABA26A0750</b>	£1,301.30
3"	<b>ABA26A0900</b>	£1,379.56
4"	<b>ABA26A1100</b>	£1,920.67

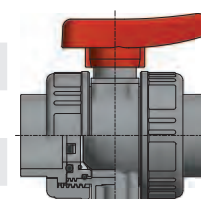

**PSACT**

**ABS Pneumatically Actuated Double Union Industrial Ball Valves Imperial**  
 Pneumatic Spring Return Double Union Industrial Ball Valve – Plain Sockets FKM Seals

Nominal Size	Code	Price each
1/2"	<b>ABA27A0200</b>	£449.48
3/4"	<b>ABA27A0250</b>	£458.37
1"	<b>ABA27A0320</b>	£476.35
1 1/4"	<b>ABA27A0400</b>	£541.09
1 1/2"	<b>ABA27A0500</b>	£574.63
2"	<b>ABA27A0630</b>	£621.65
2 1/2"	<b>ABA27A0750</b>	£1,372.89
3"	<b>ABA27A0900</b>	£1,457.85
4"	<b>ABA27A1100</b>	£2,025.86

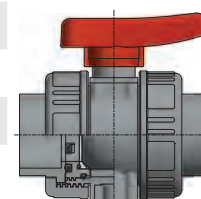

# PVC-u Electrically Actuated Butterfly Valves Metric

**PSAQU**

**PVC-u Electrically Actuated Butterfly Valves Metric**  
Electrically Actuated On/Off Butterfly Valve EPDM Seals

Nominal size	Code	Price each
63-75	<b>RBI90I0750</b>	£2,166.68
90	<b>RBI90I0900</b>	£2,220.06
110	<b>RBI90I1100</b>	£2,275.74
125	<b>RBI90I1250</b>	£2,673.65
140	<b>RBI90I1400</b>	£2,841.14
160	<b>RBI90I1600</b>	£2,763.96
200-225	<b>RBI90I2250</b>	£5,275.25
315	<b>RBI90I3150</b>	£3,869.87

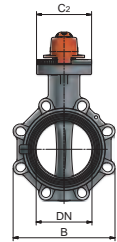

**PSAQU**

**PVC-u Electrically Actuated Butterfly Valves Metric**  
Electrically Actuated On/Off Butterfly Valve FKM Seals

Nominal size	Code	Price each
63-75	<b>RBI91I0750</b>	£2,166.68
90	<b>RBI91I0900</b>	£2,220.06
110	<b>RBI91I1100</b>	£2,275.74
125	<b>RBI91I1250</b>	£2,673.65
140	<b>RBI91I1400</b>	£2,708.42
160	<b>RBI91I1600</b>	£2,763.96
200-225	<b>RBI91I2250</b>	£2,769.95
315	<b>RBI91I3150</b>	£3,869.87

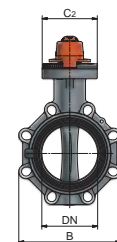

# PVC-u Pneumatically Actuated Butterfly Valves Metric

## PSAQU

**PVC-u Pneumatically Actuated Butterfly Valves Metric**  
Pneumatic Single Acting/Spring Return Butterfly Valve EPDM Seals

Nominal size	Code	Price each
63-75	RBI92I0750	£1,661.53
90	RBI92I0900	£1,715.29
110	RBI92I1100	£1,788.27
125	RBI92I1250	£1,895.87
140	RBI92I1400	£1,951.41
160	RBI92I1600	£2,383.76
200-225	RBI92I2250	£3,069.49

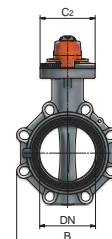

## PSAQU

**PVC-u Pneumatically Actuated Butterfly Valves Metric**  
Pneumatic Single Acting/Spring Return Butterfly Valve FKM Seals

Nominal size	Code	Price each
63-75	RBI93I0750	£1,764.66
90	RBI93I0900	£1,930.92
110	RBI93I1100	£2,151.91
125	RBI93I1250	£2,120.16
140	RBI93I1400	£2,280.92
160	RBI93I1600	£2,758.34
200-225	RBI93I2250	£3,769.72

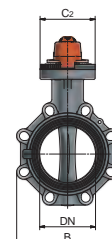

## PSAQU

**PVC-u Pneumatically Actuated Butterfly Valves Metric**  
Pneumatic Double Acting Butterfly Valve EPDM Seals

Nominal size	Code	Price each
63-75	RBI94I0750	£1,481.50
90	RBI94I0900	£1,529.50
110	RBI94I1100	£1,594.46
125	RBI94I1250	£1,690.48
140	RBI94I1400	£1,739.98
160	RBI94I1600	£2,125.41
200-225	RBI94I2250	£2,736.98

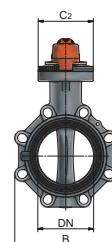

**PSAQU**
**PVC-u Pneumatically Actuated Butterfly Valves Metric**  
 Pneumatic Double Acting Butterfly Valve FKM Seals

Nominal size	Code	Price each
63-75	<b>RBI95I0750</b>	£1,499.96
90	<b>RBI95I0900</b>	£1,641.30
110	<b>RBI95I1100</b>	£1,829.10
125	<b>RBI95I1250</b>	£1,802.08
140	<b>RBI95I1400</b>	£1,938.86
160	<b>RBI95I1600</b>	£2,344.60
200-225	<b>RBI95I2250</b>	£3,204.30

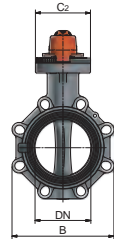

## Actuation Accessories

**PSACS**
**Actuation Accessories**

Code	Description	Price each
<b>PNSWITCHBOX</b>	Mechanical Switch Box For Pneumatic Actuator	£68.34
<b>PNCSOL24DC</b>	Solenoid Valve Single Coil 24V DC	£55.07
<b>PNCSOL24AC</b>	Solenoid Valve Single Coil 24V AC	£55.07
<b>PNCSOL11AC</b>	Solenoid Valve Single Coil 110V AC	£55.07
<b>PNCSOL23AC</b>	Solenoid Valve Single Coil 230V AC	£55.07
<b>ELECMOD2085</b>	Electric Modulator for models 20-85	£464.61
<b>ELECMOD1430</b>	Electric Modulator for modls 140 & 300	£576.49
<b>ELFSAFE2085</b>	Electric Fail Safe for models 20-85	£487.17
<b>ELFSAFE1430</b>	Electric Fail Safe for models 140 & 300	£676.62



## Accessories



## PSFAC

### Backing Rings

Galvanised Mild Steel Drilled to BS10 Table D/E

Nominal Size	Code	Price each
½"	MTABEA0200	£23.85
¾"	MTABEA0250	£24.55
1"	MTABEA0320	£27.63
1¼"	MTABEA0400	£28.08
1½"	MTABEA0500	£34.66
2"	MTABEA0630	£48.86
2½"	MTABEA0750	£67.14
3"	MTABEA0900	£73.95
4"D	MTABEA110D	£96.20
4"E	MTABEA110E	£96.20
5"	MTABEA1400	£158.65
6"	MTABEA1600	£158.65
8"	MTABEA2250	£301.64



## PSFAC

### Backing Rings

Galvanised Mild Steel Drilled to ASA150

Nominal Size	Code	Price each
- ½"	MTABAA0200	£23.85
- ¾"	MTABAA0250	£24.55
- 1"	MTABAA0320	£27.63
- 1¼"	MTABAA0400	£28.08
- 1½"	MTABAA0500	£34.66
- 2"	MTABAA0630	£48.86
- 2½"	MTABAA0750	£67.14
- 3"	MTABAA0900	£73.95
- 4"	MTABAA1100	£96.20
110 -	MTABAA1100M	£96.20
- 6"	MTABAA1600	£158.65
160 -	MTABAA1600M	£158.65
8"	MTABAA2250	£301.64



## PSFAC

### Backing Rings

Galvanised Mild Steel Drilled to BS4504 NP10/16

Metric	Imperial	Code	Price each
20	½"	MTIBNI0200	£21.53
25	¾"	MTIBNI0250	£22.11
32	1"	MTIBNI0320	£24.94
40	1¼"	MTIBNI0400	£25.31
50	1½"	MTIBNI0500	£31.23
63	2"	MTIBNI0630	£44.05
75	2½"	MTIBNI0750	£60.52
90	3"	MTIBNI0900	£67.08
4"	4"	MTIBNI1100	£86.69
110	-	MTIBNI1100M	£86.69
125	-	MTIBNI1250	£90.63
140	5"	MTIBNI1400	£136.81
-	6"	MTIBNI1600	£144.22
160	-	MTIBNI1600M	£176.94
200	-	MTIBNI2000	£205.51
225	8"	MTIBNI2250	£197.58
250	-	MTIBNI2500M	£466.76
315	-	MTIBNI3150M	£692.75



## PSFAC

### Backing Rings

PVC-u Backing Ring Drilled to BS4504 NP/10/16

Metric	Imperial	Code	Price each
20	½"	RFIFLI0200	£12.09
25	¾"	RFIFLI0250	£12.47
32	1"	RFIFLI0320	£13.45
40	1¼"	RFIFLI0400	£17.19
50	1½"	RFIFLI0500	£21.06
63	2"	RFIFLI0630	£29.89
75	2½"	RFIFLI0750	£42.61
90	3"	RFIFLI0900	£45.43
110	-	RFIFLI1100	£58.14
125	-	RFIFLI1250	£64.67
140	5"	RFIFLI1400	£81.25
160	-	RFIFLI1600	£96.59
200	-	RFIFLI2000	£144.79
225	8"	RFIFLI2250	£194.55





**PSFAC**

**Gaskets:** Flat Gaskets for Full Face Flanges  
Drilled to BS10 Table D/E EPDM

Nominal Size	Code	Price each
1"	<b>EPAGFA0320</b>	£7.91
1¼"	<b>EPAGFA0400</b>	£9.24
1½"	<b>EPAGFA0500</b>	£15.84
2"	<b>EPAGFA0630</b>	£16.48
2½"	<b>EPAGFA0750</b>	£18.59
3"	<b>EPAGFA0900</b>	£18.98
4E"	<b>EPAGFA110E</b>	£27.71
6"	<b>EPAGFA1600</b>	£37.41
8"	<b>EPAGFA2250</b>	£41.68



**PSFAC**

**Gaskets**  
Flat Gaskets for Stub Flanges

Metric	Imperial	Code	Price each
½"	20	<b>EPAGSA0200</b>	£3.46
¾"	25	<b>EPAGSA0250</b>	£4.10
1"	32	<b>EPAGSA0320</b>	£5.59
1¼"	40	<b>EPAGSA0400</b>	£6.40
1½"	50	<b>EPAGSA0500</b>	£6.88
2"	63	<b>EPAGSA0630</b>	£7.07
2½"	75	<b>EPAGSA0750</b>	£7.47
3"	90	<b>EPAGSA0900</b>	£8.35
4"	110	<b>EPAGSA1100</b>	£11.96
-	125	<b>EPAGSA1250</b>	£16.72
5"	140	<b>EPAGSA1400</b>	£17.31
6"	160	<b>EPAGSA1600</b>	£17.46
-	200	<b>EPAGSA2000</b>	£23.69
8"	225	<b>EPAGSA2250</b>	£36.70
12"	315	<b>EPAGSA3150</b>	£72.95



**PSFAC**

**Gaskets:** Flat Gaskets for Full Face Flanges  
Drilled to BS4504 NP/10/16 EPDM

Metric	Imperial	Code	Price each
20	½"	<b>EPIGFI0200</b>	£5.40
25	¾"	<b>EPIGFI0250</b>	£5.81
32	1"	<b>EPIGFI0320</b>	£7.76
40	1¼"	<b>EPIGFI0400</b>	£9.24
50	1½"	<b>EPIGFI0500</b>	£12.64
63	2"	<b>EPIGFI0630</b>	£13.67
75	2½"	<b>EPIGFI0750</b>	£18.59
90	3"	<b>EPIGFI0900</b>	£18.98
110	4"	<b>EPIGFI1100</b>	£27.71
160	6"	<b>EPIGFI1600</b>	£45.20
225	8"	<b>EPIGFI2250</b>	£49.44



**PSFAC**

**EPDM Gaskets for Tank Connectors**

Nominal Size	Code	Price each
½"	<b>EPATCA0200</b>	£2.04
¾"	<b>EPATCA0250</b>	£2.16
1"	<b>EPATCA0320</b>	£2.43
1¼"	<b>EPATCA0400</b>	£2.82
1½"	<b>EPATCA0500</b>	£3.06
2"	<b>EPATCA0630</b>	£3.47
2½"	<b>EPATCA0750</b>	£7.32
3"	<b>EPATCA0900</b>	£8.20
4"	<b>EPATCA1100</b>	£9.06



## PSFAC

### Pipe Clips, Clamps and Brackets PVC & ABS Pipe Bracket with Safety Clip

Nominal Size	Code	Price each
3/8"	RFABCA0160	£3.29
1/2"	RFABCA0200	£4.61
3/4"	RFABCA0250	£5.59
1"	RFABCA0320	£5.81
1 1/4"	RFABCA0400	£6.21
1 1/2"	RFABCA0500	£8.64
2"	RFABCA0630	£10.93
3"	RFABCA0900	£20.07
4"	RFABCA1100	£31.12
5"	RFABCA1400	£36.96
6"	RFABCA1600	£46.19



## PSFAC

### Pipe Clips, Clamps and Brackets Universal Pipe Clamp

Nominal Size	Code	Price each
20 / 1/2"	PFBPTB0200	£2.98
25 / 3/4"	PFBPTB0250	£3.40
32 / 1"	PFBPTB0320	£3.81
40 / 1 1/4"	PFBPTB0400	£3.99
50 / 1 1/2"	PFBPTB0500	£5.04
63 / 2"	PFBPTB0630	£5.19
75 / 2 1/2"	PFBPTB0750	£15.65
90 / 3"	PFBPTB0900	£19.29

## PSFAC

### Pipe Clips, Clamps and Brackets Pipe Bracket

Nominal Size	Code	Price each
1/2"	PFAPTA0200	£1.84
3/4"	PFAPTA0250	£2.07
1"	PFAPTA0320	£2.51
1 1/4"	PFAPTA0400	£3.28
1 1/2"	PFAPTA0500	£3.68
2"	PFAPTA0630	£4.95



## PSFAC

### Pipe Clips, Clamps and Brackets Pipe Bracket

Nominal Size	Code	Price each
20	PFIPTI0200	£1.84
25	PFIPTI0250	£2.08
32	PFIPTI0320	£2.55
40	PFIPTI0400	£3.28
50	PFIPTI0500	£3.86
63	PFIPTI0630	£4.64



## PSFAC

### Pipe Clips, Clamps and Brackets PVC & ABS Pipe Bracket with Safety Clip

Nominal Size	Code	Price each
16	RFIBCI0160	£3.45
20	RFIBCI0200	£4.25
25	RFIBCI0250	£4.29
32	RFIBCI0320	£4.88
40	RFIBCI0400	£6.21
50	RFIBCI0500	£7.28
63	RFIBCI0630	£9.01
75	RFIBCI0750	£13.07
90	RFIBCI0900	£16.29
110	RFIBCI1100	£28.50
125	RFIBCI1250	£29.52
140	RFIBCI1400	£29.05
160	RFIBCI1600	£44.50



**PSFAC**

**Solvent Cement and PTFE Tape**  
Solvent Cement for PVCu†

Nominal Size	Code	Price each
500ml tin	RTORCO0500	£62.71



**PSFAC**

**Solvent Cement and PTFE Tape**  
HCR 36 Cleaner\*

Nominal Size	Code	Price each
500ml tin	CTOHCR36	£97.11



**PSFAC**

**Solvent Cement and PTFE Tape**  
Effast Tite'n Fast

Nominal Size	Code	Price each
245ml tin	RTORDO0250	£38.59
485ml tin	RTORDO0500	£59.63



**PSFAC**

**Solvent Cement and PTFE Tape**  
Brushes for Solvent Cement

Nominal Size	Code	Price each
25mm	BTOBRO0250	£2.94
50mm	BTOBRO0500	£6.66



**PSFAC**

**Solvent Cement and PTFE Tape**  
Solvent Cement for ABS†

Nominal Size	Code	Price each
500ml tin	ATOACO0500	£51.59



**PSFAC**

**Solvent Cement and PTFE Tape**  
PTFE Tape

Nominal Size	Code	Price each
12mm	PTOPTFE12	£3.40



**PSFAC**

**Solvent Cement and PTFE Tape**  
Cleaning Fluid for PVCu and ABS \*

Nominal Size	Code	Price each
500ml tin	CTORMO0500	£44.57



**PSFAC**

**Solvent Cement and PTFE Tape**  
HCR 36 Chemically Resistant Solvent Cement†

Nominal Size	Code	Price each
500ml tin	RTOHCR36	£243.04



## PSFAC

### PVCu and ABS Valve Spares PVCu Valve Nut

Nominal Size	Code	Price each
½" / 20	RBAGHA0200	£4.57
¾" / 25	RBAGHA0250	£5.13
1" / 32	RBAGHA0320	£6.91
1¼" / 40	RBAGHA0400	£8.29
1½" / 50	RBAGHA0500	£11.09
2" / 63	RBAGHA0630	£17.44
2½" / 75	RBAGHA0750	£57.27
3" / 90	RBAGHA0900	£57.27
4" / 110	RBAGHA1100	£106.11



## PSFAC

### PVCu and ABS Valve Spares ABS Socket End Connectors Plain

Nominal Size	Code	Price each
¾"	ABAMCA0160	£5.65
½"	ABAMCA0200	£6.17
¾"	ABAMCA0250	£6.70
1"	ABAMCA0320	£8.76
1¼"	ABAMCA0400	£13.59
1½"	ABAMCA0500	£17.73
2"	ABAMCA0630	£20.52
2½"	ABAMCA0750	£58.08
3"	ABAMCA0900	£72.44
4"	ABAMCA1100	£90.40



## PSFAC

### PVCu and ABS Valve Spares ABS Valve Nut

Nominal Size	Code	Price each
½"	ABAGHA0200	£5.13
¾"	ABAGHA0250	£6.30
1"	ABAGHA0320	£7.85
1¼"	ABAGHA0400	£10.18
1½"	ABAGHA0500	£12.58
2"	ABAGHA0630	£19.54
2½"	ABAGHA0750	£64.14
3"	ABAGHA0900	£60.92
4"	ABAGHA1100	£119.63



## PSFAC

### PVCu and ABS Valve Spares PVCu Socket End Connector Plain Metric

Nominal Size	Code	Price each
16	RBIMCI0160	£4.82
20	RBIMCI0200	£5.09
25	RBIMCI0250	£5.90
32	RBIMCI0320	£7.37
40	RBIMCI0400	£11.69
50	RBIMCI0500	£15.16
63	RBIMCI0630	£17.66
75	RBIMCI0750	£52.12
90	RBIMCI0900	£61.58
110	RBIMCI1100	£77.50



## PSFAC

### PVCu and ABS Valve Spares PVCu Socket End Connector Plain Imperial

Nominal Size	Code	Price each
¾"	RBAMCA0160	£4.82
½"	RBAMCA0200	£5.09
¾"	RBAMCA0250	£5.90
1"	RBAMCA0320	£7.37
1¼"	RBAMCA0400	£11.69
1½"	RBAMCA0500	£15.16
2"	RBAMCA0630	£17.66
2½"	RBAMCA0750	£52.06
3"	RBAMCA0900	£61.58
4"	RBAMCA1100	£77.50



## PSFAC

### PVCu and ABS Valve Spares PVCu End Connector BSP Female Threaded

Nominal Size	Code	Price each
¾"	RBFMCF0160	£9.38
½"	RBFMCF0200	£9.65
¾"	RBFMCF0250	£11.86
1"	RBFMCF0320	£13.20
1¼"	RBFMCF0400	£19.43
1½"	RBFMCF0500	£25.03
2"	RBFMCF0630	£35.61
2½"	RBFMCF0750	£71.44
3"	RBFMCF0900	£90.61
4"	RBFMCF1100	£112.78

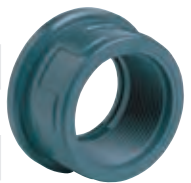

## PSFAC

### PVCu and ABS Valve Spares Industrial Ball Valve Handle Orange

Nominal Size	Code	Price each
3/8"	RBAMOA0160	£5.94
1/2"	RBAMOA0200	£6.17
3/4"	RBAMOA0250	£6.97
1"	RBAMOA0320	£9.17
1 1/4"	RBAMOA0400	£10.41
1 1/2"	RBAMOA0500	£13.35
2"	RBAMOA0630	£15.85
2 1/2"	RBAMOA0750	£32.85
3"	RBAMOA0900	£37.25
4"	RBAMOA1100	£49.79



## PSFAC

### PVCu and ABS Valve Spares EPDM and PTFE Seal Kits for Industrial Ball Valves

Nominal Size	Code	Price each
3/8"	EBDSED0160	£27.49
1/2"	EBDSED0200	£27.95
3/4"	EBDSED0250	£35.22
1"	EBDSED0320	£47.85
1 1/4"	EBDSED0400	£70.20
1 1/2"	EBDSED0500	£82.79
2"	EBDSED0630	£141.51
2 1/2"	EBDSED0750	£219.89
3"	EBDSED0900	£241.17
4"	EBDSED1100	£297.05



## PSFAC

### PVCu and ABS Valve Spares Water Supply Ball Valve Handle Blue

Nominal Size	Code	Price each
3/8"	RBAMBA0160	£5.94
1/2"	RBAMBA0200	£6.17
3/4"	RBAMBA0250	£6.97
1"	RBAMBA0320	£9.17
1 1/4"	RBAMBA0400	£10.41
1 1/2"	RBAMBA0500	£13.66
2"	RBAMBA0630	£15.85
2 1/2"	RBAMBA0750	£32.85
3"	RBAMBA0900	£37.25
4"	RBAMBA1100	£49.79



## PSFAC

### PVCu and ABS Valve Spares FKM and PTFE Seal Kits for Industrial Ball Valves

Nominal Size	Code	Price each
3/8"	EBVSEV0160	£43.99
1/2"	EBVSEV0200	£44.92
3/4"	EBVSEV0250	£56.58
1"	EBVSEV0320	£76.26
1 1/4"	EBVSEV0400	£112.42
1 1/2"	EBVSEV0500	£134.42
2"	EBVSEV0630	£198.98
2 1/2"	EBVSEV0750	£352.07
3"	EBVSEV0900	£386.00
4"	EBVSEV1100	£425.61



## PSFAC

### PVCu and ABS Valve Spares Actuator Bracket for Double Union Industrial Ball Valve with Universal Mounting Block

Nominal Size	Code	Price each
1" / 32	PBMSVM0320A	£220.87
1 1/4" / 40	PBMSVM0400A	£235.52
1 1/2" / 50	PBMSVM0500A	£242.94
2" / 63	PBMSVM0630A	£250.27
2 1/2" / 75	PBMSVM0750	£917.84
3" / 90	PBMSVM0900	£917.84
4" / 110	PBMSVM1100	£1,094.57



## PSPVF

### PVCu and ABS Valve Spares Ball Valve Locking Cap

Nominal Size	Code	Price each
1/2"	BDRHTA0200	£0.95
3/4"	BDRHTA0250	£1.11
1"	BDRHTA0320	£1.91
1 1/4"	BDRHTA0400	£1.91
1 1/2"	BDRHTA0500	£3.28
2"	BDRHTA0630	£3.45



## PSFAC

### PVCu and ABS Valve Spares Strainer for Foot Valves

Nominal Size (d)	Code	Price each
½"	CDRZVD0200	£19.92
¾"	CDRZVD0250	£22.92
1"	CDRZVD0320	£27.63
1¼"	CDRZVD0400	£32.12
1½"	CDRZVD0500	£48.03
2"	CDRZVD0630	£57.52
2½"	CDRZVD0750	£80.50
3"	CDRZVD0900	£81.50
4"	CDRZVD1100	£87.27



## PSFAC

### PVCu and ABS Union Spares PVCu Union Bush Plain

Nominal Size	Code	Price each
½"	RFABFA0200	£6.57
¾"	RFABFA0250	£8.22
1"	RFABFA0320	£9.49
1¼"	RFABFA0400	£14.19
1½"	RFABFA0500	£17.47
2"	RFABFA0630	£18.84
2½"	RFABFA0750	£55.94
3"	RFABFA0900	£66.09
4"	RFABFA1100	£75.83



## PSFAC

### PVCu and ABS Union Spares EPDM O Rings for Unions

Nominal Size	Code	Price each
¾" / 16	EPOGBO0160	£2.82
½" / 20	EPOGBO0200	£3.12
¾" / 25	EPOGBO0250	£3.17
1" / 32	EPOGBO0320	£3.47
1¼" / 40	EPOGBO0400	£6.53
1½" / 50	EPOGBO0500	£4.17
2" / 63	EPOGBO0630	£4.41
2½" / 75	EPOGBO0750	£8.31
3" / 90	EPOGBO0900	£9.29
4" / 110	EPOGBO1100	£9.77



## PSFAC

### PVCu and ABS Union Spares PVCu Union End Plain

Nominal Size	Code	Price each
½"	RFABLA0200	£7.69
¾"	RFABLA0250	£9.00
1"	RFABLA0320	£10.48
1¼"	RFABLA0400	£12.03
1½"	RFABLA0500	£24.23
2"	RFABLA0630	£31.07
2½"	RFABLA0750	£38.30
3"	RFABLA0900	£80.97
4"	RFABLA1100	£97.51



## PSFAC

### PVCu and ABS Union Spares FKM O Rings for Unions

Nominal Size	Code	Price each
½" / 20	EPOGBV0200	£8.85
¾" / 25	EPOGBV0250	£13.45
1" / 32	EPOGBV0320	£15.27
1¼" / 40	EPOGBV0400	£35.20
1½" / 50	EPOGBV0500	£39.33
2" / 63	EPOGBV0630	£43.47



## PSFAC

### PVCu and ABS Union Spares PVCu Union Nut

Nominal Size	Code	Price each
½"	RFABGA0200	£12.92
¾"	RFABGA0250	£15.04
1"	RFABGA0320	£24.60
1¼"	RFABGA0400	£25.77
1½"	RFABGA0500	£36.79
2"	RFABGA0630	£47.89
2½"	RFABGA0750	£110.39
3"	RFABGA0900	£132.20
4"	RFABGA1100	£154.88



**PSFAC**

**PVCu and ABS Union Spares**  
PVCu Union Bush BSP Female Threaded

Nominal Size	Code	Price each
3/8"	RFFBFF0160	£6.99
1/2"	RFFBFF0200	£7.31
3/4"	RFFBFF0250	£8.77
1"	RFFBFF0320	£10.14
1 1/4"	RFFBFF0400	£15.08
1 1/2"	RFFBFF0500	£18.47
2"	RFFBFF0630	£20.01
2 1/2"	RFFBFF0750	£59.29
3"	RFFBFF0900	£68.78
4"	RFFBFF1100	£78.90



**PSFAC**

**PVCu and ABS Union Spares**  
PVC Union Bush Plain Metric

Nominal Size	Code	Price each
16	RFIBFI0160	£6.66
20	RFIBFI0200	£7.06
25	RFIBFI0250	£8.29
32	RFIBFI0320	£9.57
40	RFIBFI0400	£14.31
50	RFIBFI0500	£17.64
63	RFIBFI0630	£19.01
75	RFIBFI0750	£56.95
90	RFIBFI0900	£66.64
110	RFIBFI1100	£76.48



**PSFAC**

**PVCu and ABS Union Spares**  
PVCu Union End BSP Female Threaded

Nominal Size	Code	Price each
3/8"	RFFBLF0160	£5.00
1/2"	RFFBLF0200	£4.25
3/4"	RFFBLF0250	£5.04
1"	RFFBLF0320	£5.91
1 1/4"	RFFBLF0400	£6.73
1 1/2"	RFFBLF0500	£13.72
2"	RFFBLF0630	£17.21
2 1/2"	RFFBLF0750	£26.87
3"	RFFBLF0900	£44.94
4"	RFFBLF1100	£54.07

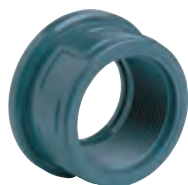

**PSFAC**

**PVCu and ABS Union Spares**  
PVCu Union End Plain Metric

Nominal Size	Code	Price each
16	RFIBLI0160	£7.69
20	RFIBLI0200	£8.13
25	RFIBLI0250	£9.00
32	RFIBLI0320	£10.48
40	RFIBLI0400	£12.03
50	RFIBLI0500	£24.23
63	RFIBLI0630	£31.07
75	RFIBLI0750	£38.98
90	RFIBLI0900	£80.97
110	RFIBLI1100	£97.51





## PSFAC

### PVCu and ABS Union Spares ABS Union End Plain

Nominal Size	Code	Price each
½"	AFABLA0200	£8.48
¾"	AFABLA0250	£9.48
1"	AFABLA0320	£11.96
1¼"	AFABLA0400	£13.58
1½"	AFABLA0500	£27.31
2"	AFABLA0630	£35.11
2½"	AFABLA0750	£43.84
3"	AFABLA0900	£91.18
4"	AFABLA1100	£109.60



## PSFAC

### PVCu and ABS Union Spares ABS Union Nut

Nominal Size	Code	Price each
½"	AFABGA0200	£14.36
¾"	AFABGA0250	£16.67
1"	AFABGA0320	£27.63
1¼"	AFABGA0400	£28.91
1½"	AFABGA0500	£41.77
2"	AFABGA0630	£54.25
2½"	AFABGA0750	£124.05
3"	AFABGA0900	£149.17
4"	AFABGA1100	£174.20



## PSFAC

### PVCu and ABS Union Spares ABS Union Bush Plain

Nominal Size	Code	Price each
½"	AFABFA0200	£7.47
¾"	AFABFA0250	£8.10
1"	AFABFA0320	£10.48
1¼"	AFABFA0400	£15.65
1½"	AFABFA0500	£19.21
2"	AFABFA0630	£20.70
2½"	AFABFA0750	£61.12
3"	AFABFA0900	£71.57
4"	AFABFA1100	£78.81

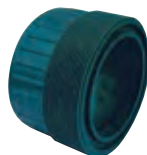









# Guide to solvent jointing

## Important Information

- Always use Personal Protective Equipment - gloves and eye protection
- Always carry out work in a well ventilated area
- Always refer to Material Safety Data Sheets
- Dispose of waste responsibly
- Failure to follow the jointing procedure may invalidate any warranties given

Procedure		Equipment								
<p>1. Cut the pipe at right angles to its axis and to the required length.</p> <p>Deburr the cut end of the pipe with a sharp knife or scraper.</p>		Pipe cutter Saw Scraper or knife								
<p>2. Chamfer the leading edge of the pipe at approximately 15° to 30°.</p> <p>This will prevent the solvent cement being wiped from both the pipe and fitting when mated together and will also help to build up a ring of solvent around the chamfer, thus ensuring a proper seal.</p>	 <table border="1"> <thead> <tr> <th>Pipe Size</th> <th>Chamfer size (mm)</th> </tr> </thead> <tbody> <tr> <td>3/8" (16mm)</td> <td>2</td> </tr> <tr> <td>1/2" - 1 1/2" (20 - 50mm)</td> <td>3 - 4</td> </tr> <tr> <td>2" - 8" (63 - 225mm)</td> <td>5 - 6</td> </tr> </tbody> </table>	Pipe Size	Chamfer size (mm)	3/8" (16mm)	2	1/2" - 1 1/2" (20 - 50mm)	3 - 4	2" - 8" (63 - 225mm)	5 - 6	Chamfering tool Fine disc angle grinder, file or abrasive paper (80 - 100 grit)
Pipe Size	Chamfer size (mm)									
3/8" (16mm)	2									
1/2" - 1 1/2" (20 - 50mm)	3 - 4									
2" - 8" (63 - 225mm)	5 - 6									
<p>3. Mark the pipe back from the chamfered end to a length equal to the socket depth plus 5mm.</p> <p>This mark will act as a visual indicator to show that the pipe is fully inserted into the socket.</p>		Marker pen								
<p>4. Roughen or clean the pipe surface with solvent cleaner (up to the indicator mark) and the inside of the socket. Do not roughen the pipe and fitting to the extent that the clearance between them is noticeably increased.</p>		Abrasive paper / cloth (80 - 100 grit)								
<p>5. Clean the inner surface of the socket and the surface of the pipe up to the mark using a lint free cloth or absorbent paper dampened with Effast solvent cleaner.</p>		Lint free cloth or absorbent paper Effast solvent cleaner								
<p>6. Select the correct solvent cement, PVCu to PVCu, ABS to ABS (failure to use the recommended solvent cement may invalidate any warranties given). Apply the cement straight from the tin and ensure all relevant surfaces are covered.</p> <p>Read the instructions on the tin. Avoid using excessive amounts of solvent cement.</p>		Effast PVCu cement Effast ABS cement Brush (half the diameter of the socket)								
<p>Joints are normally made in temperatures between 5 - 25°C. The maximum time before the cement is too dry for jointing is approximately 3 minutes. In hot weather this time is reduced, but the joint must still be made whilst the cement is wet. At temperatures below 5°C the curing time will be considerably increased.</p>										
<p>7. Push fittings/pipe together without twisting and ensure that they are aligned and fully engaged (the indicator mark should be in line with the edge of the socket) then hold the assembly for a short time as specified.</p>										

Pipe size	Holding Time (minutes)
3/8" - 2" (16mm - 63mm)	1/2
2 1/2" - 4" (75 - 119mm)	3/4
5" - 8" (140 - 225mm)	1
10" - 12" (250 - 315mm)	2

## Post-weld Procedure

When the joint is made, an O-ring of cement is formed between the pipe chamfer and the internal socket wall. This ring helps to ensure seal integrity. A bead of cement will show around the external junction of the pipe and fitting, this should be wiped off leaving the outer part of the joint clean. Do not disturb for at least 10 - 15 minutes to ensure that the weld integrity is maintained. After this period, the assembly can be carefully handled, prepared for further jointing or left for the recommended curing time which is:

Up to 8" (225mm)

After 8 hours      The joint will have cured enough to withstand the working pressure

After 24 hours     The pipe system can be fully pressure tested

The number of operators:

For joints of up to 2½" (75mm) 1 person is required, from 3" (90mm) up to 6" (160mm) 2 persons are needed, for 8" (225mm) and above 3 people are required.

Pipe work should be ventilated during the joining and curing processes. Never seal a pipe system which has been newly jointed as the trapped vapours can cause damage. Positive ventilation with a small air blower is recommended to purge systems with multiple joints.

## Recommended Joints per Litre of Effast Cement

Pipe Size		Thermoplastic Material	
Inch	mm	PVCu	ABS
¾" - 1"	16 - 32	300	400
1¼" - 2"	40 - 63	120	175
2½" - 3"	75 - 90	50	70
4"	110	30	45
5"	140	20	30
6"	160	15	25
8"	200 - 225	8	15
10"	250 - 280	3	4
12"	315	3	4

### Important points

- Heavy equipment should be supported independently from the pipeline. i.e. valves, strainers, etc
- Pipe clips should be made to allow linear expansion of the pipeline, and if lined the lining should be of a material compatible with the pipeline.
- Mastics, intumescent mastics, adhesive tapes and labels should not be used (as many degrade plastics), unless manufacturers provide documents of adhesive or mastic compatibility.
- Insulation must be considered very carefully, as a number of foam rubber insulation products and their adhesives may not be compatible with plastic pipes. Adhesives should only be used to bond the foam edges together, and should never be used to bond the insulation to the pipeline. Refer to manufacturers for compatibility data. For example, compatible insulations are fibre wools (Rockwool), polystyrene, etc.
- Trace heating tapes: Don't use tapes covered with plasticised PVC as this can react with thermoplastic pipes. Tapes with sheaths made from woven wire, polyester, or silicone rubber are acceptable.
- Oils: A number of synthetic oils are not suitable for use with plastic pipelines. Oils such as esters, organic phosphates, and polyalkylene glycols should be avoided.
- Health and safety: Solvent cement and cleaning fluid give off vapours that are dangerous to health. During jointing the work place must be well ventilated.

### Solvent Jointing - Do Not

- Make joints in rain or wet conditions.
- Use dirty brushes or cleaning rags.
- Use the same brushes with different solvent cements.
- Dilute or thin solvent cements with cleaner.
- Leave solvent cement tins open as the contents will evaporate and the cement performance will be reduced.
- Use near naked lights or smoke whilst jointing as solvents are highly inflammable.
- Make joints in a confined space as solvents emit hazardous vapours.

# Guide to chemical resistance

	Material °C Concentration	PVCu			ABS			EPDM			FKM			
		20	40	60	20	40	60	20	40	60	20	60	100	120
Acetaldehyde	technically pure	-			-			+	0	-	0	-		
	40%, aqueous solution	0	-		-			+	+	+	+	0		
Acetic Acid	technically pure,	0	-		-			0			-			
	glacial 10% aqueous	+	+	0	+	0	-	+	+	0	0	-		
Acetic Acid Anhydride	technically pure	-			-			0			-			
Acetone	technically pure	-			-			+	+	+	-			
Acrylonitrile	technically pure	-			-			+	+	0	0	-		
Adipic Acid	saturated, aqueous	+	+	0	-			+	+	+	+	+		
Alcoholic Spirits	app. 40% ethyl alcohol	+			-			+			+			
Allyl Alcohol	96%	0	-		-			0	0	0	0	-		
Aluminium Chloride	saturated	+	+	+	+	+	+	+	+	+	+	+	+	
Aluminium Sulphate	cold saturated, aqueous	+	+	+	+	+	+	+	+	+	+	+		
Ammonia	gaseous, tech. pure	+	+	+	-			+			+			
Ammonium Acetate	aqueous, all				-			+	+	+	+	+		
Ammonium Hydrogen Fluoride	50%, aqueous	+	+	0	-			+			+			
Ammonium Compounds: See Sodium														
Amyl Acetate	technically pure	-			-			0			-			
Amyl Alcohol	technically pure	+	+	0	-			+	+	+	0			
Aniline	technically pure	-			-			-			0	0		
Aniline Hydrochloride	aqueous, saturated	+	0		-			+	+	+	0	-		
Antimony Trichloride	90%, aqueous	+	+		-			+			+			
Aqua Regia		+	0		-			-			0			
Arsenic Acid	80%, aqueous	+	+	0	+	+	+	+	+	+	+	+	+	
Barium Hydroxide	aqueous, saturated	+	+	0	+	+	+	+	+	+	+	+		
Barium Salts	aqueous, all	+	+	+	+	+	+	+	+	+	+	+		
Beef Tallow Emulsion, Sulphonated	usual commercial	+						-			+			
Beer	usual commercial	+	+	+	+	+	+	+			+			
Benzaldehyde	aqueous, saturated	-			-			+	+	+	+	+		
Benzene	technically pure	-			-			-			+			
Benzine	free of lead and aromatic compounds	+	+	+	-			-			+	+		
Benzoic Acid	aqueous, all	+	+	0	+	+	0	-			+	+	0	
Benzyl Alcohol	technically pure	0			-			+			0			
Bleaching Lye	12.5% active chlorine aqueous	+	+	0	0			+			+			
Borax	aqueous, all	+	+	0	0			+	+	+	+	+		
Boric Acid	aqueous, all	+	+	0	+	+	+	+	+	+	+	+	+	
Brine, Sea Water		+	+	0	+	+	+	+	+	+	+	+	+	+
Bromine, Liquid	technically pure	-			-			-			+			
Butadiene	technically pure	+			-			-			0			
Butane	technically pure	+			+			-			+			
Butanediol	aqueous, 10%	+	0		-			+	+	+	+	+		
Butanol	technically pure	+	+	0	-			+	+	+	+	0		
Butyl Acetate	technically pure	-			-			+	-		0	-		
Butyl Phenol, P-Tertiary	technically pure	0	-		-			-			0			
Butylene Glycol	technically pure	+	+	0	+	+	+	+	+	+	+	0		
Butylene Liquid	technically pure	+			-			0			+			
Butyric Acid	technically pure	+			-			0			0			
Calcium Bisulphate	cold saturated, aqueous	+						+			+	+	+	
Calcium Chloride	saturated, aqueous, all	+	+	0	+	+	+	+	+	+	+	+	+	
Calcium Hydroxide	aqueous, saturated	+	+	+	+	+	+	+	+	+	+	+	+	
Calcium Hypochlorite	cold saturated, aqueous	+	+		+	+	-	+	+	+	+	+		
Calcium Nitrate	50%, aqueous	+	+		+	+	+	+	+	+	+	+		
Carbon Dioxide (Carbonic Acid)	technically pure, moist	+	+	0	+	+	+	+	+	+	+	+		
Carbon Disulphide	technically pure	-			-			-			+			
Carbon Tetrachloride	technically pure	-			-			-			+	+		
Caustic Soda Solution (Sodium Hydroxide)	up to 40%, aqueous	+	+	0	+	+	+	+	+	+	0	-		
	up to 50%, aqueous	+	+	+	+	+	+	+	+	0	-			
Chloral Hydrate	technically pure	-			-			0			0			
Chloric Acid	10%, aqueous	+	+	0	-			+	+	+	-			
Chlorine	moist, 97% gaseous	0			-			0			+			

= No Data    -- = Not Recommended    0 = Conditionally Resistant    + = Resistant

# Guide to chemical resistance

	Material °C Concentration	PVCu			ABS			EPDM			FKM			
		20	40	60	20	40	60	20	40	60	20	60	100	120
	anhydrous, tech.	0			–			0			+			
Chlorine	pure liquid, technically pure	–			–			–			0			
Chlorine Water	saturated	0	0		0	0		0			0			
Chloroacetic Acid, Mono	50%, aqueous	+	+		–			0			–			
Chloroenezene	technically pure	–			–			–			–			
Chloroethanol	technically pure	–			–			0			–			
Chloroform	technically pure	–			–			–			0			
Chlorosulphonic Acid	technically pure	0			–			–			–			
Chrome Alum (Chromium Potassium Sulphate)	cold saturated, aqueous	+	+	+	+	+	+	+	+	+	+	+	+	
Chrome Acid	all, aqueous	+			–			0			+	0		
Cider		+			+	+		+			+			
Citric Acid	10% aqueous	+	+	0	+	+	+	+	+	+	+	+		
Copper Salts	all, aqueous	+	+	0	+	+	+	+	+	+	+	+		
Corn Oil	technically pure	0			0			0	–		+	+		
Cresol	cold saturated, aqueous	0			–			–			+			
Crotonic Aldehyde	technically pure	–			–			+			+			
Cyclohexane	technically pure	–			–			–			+			
Cyclohexanol	technically pure	+	+	+	–			–			+			
Cyclohexanone	technically pure	–			–			0			–			
Detergents (Washing Powders)	usual washing lathers	+	+	0	–			+	+	+	+	+		
Dextrine	(Starch Gum) usual commercial	+	+	+	+	+	+	+	+	+	+	+		
Dibutyl Ether	technically pure	–			–			–			+	0		
Dibutyl Phthlate	technically pure	–			–			0			0			
Dibutyl Sebacate	technically pure	–			–			+			+			
Dichloroacetic Acid	technically pure	+	+	0	–			+	+	+	0	–		
Dichloroacetic Acid Methl Esher	technically pure	–			–			+	+	0	–			
Dichlorobenzene	technically pure	–			–			–			+			
Dichloroethylene	technically pure	–			–			–			0			
Diesel Oil		+	+		0			–			+			
Diethylamine	technically pure	0			–			0						
Di-Isobutyl Ketone	technically pure	–			–			0			–			
Dimethyl Formamide	technically pure	–			–			0			+			
Dimethylamine	technically pure	0			–			0			–			
Ethyl Acetate	technically pure	–			–			0	0	0	–			
Ethyl Alcohol	technically pure, 96%	+	+	0	–			+	+	+	0	0		
Ethyl Alcohol + Acetic Acid	fermentation mixture	+	+	0	–			+	+	0	0	0		
Ethyl Benzene	technically pure	–			–			–			0			
Ethyl Chloride	technically pure	–			–			–			0			
Ethyl Ether	technically pure	–			–			–			–			
Ethylene Chloride	technically pure	–			–			0	0	–	+	0		
Ethylene Diamine	technically pure	0			–			+	+	+	0	–		
Ethylene Glycol	technically pure	+	+	+	+	+	+	+	+	+	+	+		
Ethylene Oxide	technically pure, liquid	–			–			0			–			
Fatty Acids >C6	technically pure	+	+	+	–			–			+			
Fatty Alcohol Sulphonates	aqueous	+	+	0	–			+	+	+	+	+		
Ferric Chloride	saturated	+	+	+	–			+	+	+	+	+	+	+
Ferric Nitrate	saturated	+	+	+	+	0	–	+	+	0	+	+	+	+
Ferrous Sulphate		+	+	+	+	+	+	+	+	+	+	+	+	+
Fluosilicic Acid	32%, aqueous	+	+	+	+	+	+	0	0	–	–			
Formaldehyde	40%, aqueous	+	+		+	+	+	+	+	+	+	+		
Formamide	technically pure	–			–			+			0			
Formic Acid	technically pure	+	0	–	–			+	+	+	–			
Fruit Juices		+	+	+	+	+	+	+	+	+	+	+	+	+
Fuel Oil		+	0		0			–			+	+		
Furfuryl Alcohol	technically pure	–			–			0			–			
Gelatine	all, aqueous	+	+		+	+	+	+	+		+			
Glucose	all, aqueous	+	+	0	+	+	+	+	+	+	+	+	+	
Glycerine	technically pure	+	+	+	+	+	0	+	+	+	+	0		
Glycocol	10%, aqueous	+	+		+			+	+		+			

= No Data    – = Not Recommended    0 = Conditionally Resistant    + = Resistant

# Guide to chemical resistance

	Material °C Concentration	PVCu			ABS			EPDM			FKM			
		20	40	60	20	40	60	20	40	60	20	60	100	120
Glycolic Acid	37%, aqueous	+			+	+		+			+			
Heptane	technically pure	+			+ -			-			+	+		
Hexane	technically pure	+			+ -			-			+	+		
Hydrazine Hydrate	aqueous	+			-			+			+			
Hydrobromic Acid	50%, aqueous	+	+	+	+	+		+	+	0	+	+	-	
Hydrochloric Acid	up to 10%, aqueous	+	+	0	+	+	0 -	+	+	+	+	+		
	up to 36%, aqueous	+	+	0	-			+	0	-	+	-		
Hydrocyanic Acid	technically pure	+	+	0	+	+		+	0		+			
Hydrofluoric Acid	up to 10%, aqueous	+	0	0	+	+		-			+	0		
	40%, aqueous	+			-			-			+			
	70%, aqueous	+			-			-			+			
Hydrogen	technically pure	+	+	+	+	+	+	+	+	+	+	+	+	+
Hydrogen Chloride	tech. pure, gaseous	+	+	0	-			+	+	+	+	+		
Hydrogen Peroxide	3%, aqueous	+	+	0	+	+		+	0	-	+	-		
	30%, aqueous	+	+		-			0	-		+	0		
	90%, aqueous				-			0			0			
Hydrogen Sulphide	technically pure	+	+	+	+			+	0	-	+	0		
Iodine Solution	6.5% iodine in ethanol	-			-			+			+			
Iron Salts	all, aqueous	+	+	0	+	+		+	+	+	+	+	+	
Iso-Octane	technically pure	+			-			-			+			
Isopropyl Alcohol	technically pure	+			-			+	+	+	+	+		
Isopropyl Ether	technically pure	-			-			-			-			
Lactic Acid	10%, aqueous	+	0	-	+	0 -		0	0	0	+	0		
Lanolin	technically pure	+	0		+	+	+	0	-		+	+		
Lead Acetate	aqueous, saturated	+	+	+	+	+	+	+	+	+	+	+		
Linseed Oil	technically pure	+	+	0	+			0	-		+	+		
Lubricating Oils		+	+	+	0			-			+	+	-	
Magnesium Salts	all, aqueous	+	+	0	+	+		+	+	+	+	+	+	
Maleic Acid	cold saturated, aqueous	+	+	0	+			0	-		+	+		
Mercury	pure	+	+	+	+			+	+	+	+	+		
Mercury Salts	cold, saturated, aqueous	+	+	0	+			+	+	+	+	+		
Methane (Natural Gas)	technically pure	+			+			-			+			
Methanol	all	+	+	0	-			+	+	+	0	0		
Methyl Acetate	technically pure	-			-			0			-			
Methyl Amine	32%, aqueous	0			-			+			+			
Methyl Bromide	technically pure	-			-			-			0			
Methyl Chloride	technically pure	-			-			0			-			
Methylene Chloride	technically pure	-			-			-			0			
Methyl Ethyl Ketone	technically pure	-			-			+	0		-			
Milk		+	+	+	+	+	+	+			+			
Molasses		+	+	0	+	+	0	+	+	+	+	+		
Monochloroacetic Acid Ethyl Ester	technically pure	0			-			+			0			
Monochloroacetic Acid Methyl Ester	technically pure	0			-			+			0			
Morpholin	technically pure	-			-			0			+			
Naphthalene	technically pure	-			-			-			+	+		
Nickel Salts	cold saturated, aqueous	+	+	0	+	+	+	+	+	+	+	+	+	
Nitric Acid	5%, aqueous	+	+	+	+	0	-	+	+	0	+	0		
	up to 40%, aqueous	+	+	0	-			+	+	0	+	+		
	65%, aqueous	0	0	-	-			-			+	-		
Nitrobenzene	technically pure	-			-			-			0			
Nitroluene (O-, M-, P-)	technically pure	-			-			-			0	-		
Nitrous Gases	diluted, moist, anhydrous	+		0	0			+	+	0	+	+		
Oleic Acid	technically pure	+	+	+	+	0	-	-			+	-		
Olive Oil		+	+	+	+			-			+	+		
Oxalic Acid	cold saturated, aqueous	+	+	+	+	+		0	0	0	+	0		
Oxygen	technically pure	+	+	+	+	+	+	+	+	+	+	+	+	+
Ozone	cold saturated, aqueous	+	+		-			+	0	-	+	-		
Palmitic Acid	technically pure	+			-			0	-		+	-		
Palm Oil, Palm Nut Oil		+	-					+	0	-	+	+		

= No Data    - = Not Recommended    0 = Conditionally Resistant    + = Resistant

# Guide to chemical resistance

	Material °C Concentration	PVCu			ABS			EPDM			FKM			
		20	40	60	20	40	60	20	40	60	20	60	100	120
Paraffin Emulsions	usual comm., aqueous	+	+		–			–			+	+		
Paraffin Oil		+	+	0	+	+	+	–			+	+		
Perchloric Acid	10%, aqueous	+	+	0	+	+		+	+	+	+	+		
Perchloric Acid	70%, aqueous	0			–			+	+	+	+	+		
Perchloroethylene (Tetrachloroethylene)	technically pure	–			–			–			+	+		
Petroleum	technically pure	+			–			–			+	0		
Petroleum Ether	technically pure	+	+	+	–			–			+	0		
Petroleum Jelly	technically pure	0	–		–			–			+	+	+	+
Phenol	up to 90%, aqueous	0			–			–			+	–		
Phenylhydrazine	technically pure	–			–			0			+	0		
Phenylhydrazine Hydrochloride	aqueous	0			–			+	+	0	+	0		
Phosgene	gaseous, technically pure	+	0	0	–			+	+	+	+	0		
Phosphoric Acid	85%, aqueous	+	+	+	+	+	0	+	+	+	+	+	0	
Phosphorous Pentoxide	technically pure	+	+		+	+		+	+	+	+	+		
Photographic Developer	usual commercial	+	+	0	+	+	0	+	+		+			
Photographic Emulsion		+	+		+	+		+	+		+			
Photographic Fixer	usual commercial	+	+	0	+	+	0	+	+		+			
Phthalic Acid	saturated, aqueous	+	0	–	–			+	+	0	–			
Picric Acid	1%, aqueous	+			–			+	+	0	+	+		
Potash (Potassium Carbonate)	cold saturated, aqueous	+	+		+	+	+	+	+		+			
Potassium Permanganate	cold saturated, aqueous	+	+	0	–			+	+	+	+	+		
Potassium Compounds: See Sodium														
Propane	technically pure, liquid	+			+			–			+			
Propanol, N- And Iso-	technically pure	+	0	0	–			+	+	+	+	+		
Propionic Acid 50%, Aqueous		+	+	0	–			+	+	+	+	0		
Propylene Glycol	technically pure	+	+	+	0			+	+	+	+	0		
Propylene Oxide	technically pure	0			–			+			–			
Pyridine	technically pure	–			–			+	0	–	0	–		
Silicone Oil		+	0	–	+			0	–		+	+		
Silver Salts	cold saturated, aqueous	+	+	0	+	+	+	+	+	+	+	+		
Soap Solution	all, aqueous	+	+	0	+	+	+	+	+	+	+	+		
Sodium Acetate	all, aqueous	+			+	+	+	+	+	+	+	+		
Sodium Benzoate	cold saturated, aqueous	+	+	0	–			+	+	+	+	+		
Sodium Bicarbonate	cold saturated, aqueous	+	+	+				+	+	+	+	+		
Sodium Bisulphate	10%, aqueous	+	+	0				+	+	+	+	+	+	
Sodium Bisulphite	all, aqueous	+	0	–	+	+	+	+	+	+	0	–		
Sodium Bromate	all, aqueous	+	0		+	+	+	+	+	+	+	+		
Sodium Bromide	all, aqueous	+	+	0	+	+	+	+	+	+	+	+		
Sodium Carbonate (Soda)	cold saturated, aqueous	+	+	+	+	+	+	+	+	+	+	+		
Sodium Chlorate	all, aqueous	+	+	0	+	+	+	+	+	+	+	+		
Sodium Chloride	all, aqueous	+	+	0	+	+	+	+	+	+	+	+	+	
Sodium Chlorite	diluted, aqueous	0						+	+	+	+	+		
Sodium Chromate	10%, aqueous	+	+	0	+	+	+	+	+	+	+	+		
Sodium Disulphate	all, aqueous	+	+	0				+	+	+	+	+		
Sodium Dithionite (Hyposulphite)	up to 10%, aqueous	+	+	0				+	+	+	+	+		
Sodium Fluoride	cold saturated, aqueous	+	+		+	+	+	+	+	+	+	+		
Sodium Hydroxide See Caustic Soda														
Sodium Hypochlorite	aqueous (12.5% active)	+	+	0	–			+			+			
Sodium Iodide	all, aqueous	+	+	0	+	+	+	+	+	+	+	+		
Sodium Nitrate	cold saturated, aqueous	+	+	0	+	+		+	+	+	+	+		
Sodium Nitrite	cold saturated, aqueous	+			+	+	+	+	+	+	+	+		
Sodium Oxalate	cold saturated, aqueous	+	+	0				+			+			
Sodium Persulphate	cold saturated, aqueous	+	+	0				+	+	+	+	+	+	
Sodium Phosphate	cold saturated, aqueous	+	+	0	+	–		+	+	+	+	+		
Sodium Silicate	all, aqueous	+	+	0	+	+	+	+	+	+	+	+		
Sodium Sulphate	cold saturated, aqueous	+	+	0	+	+	+	+	+	0	+	+		
Sodium Sulphide	cold saturated, aqueous	+	+	0	+	+	+	+	+	+	–			
Sodium Sulphite	cold saturated, aqueous	+	+	0	+	+		+	+	+	+	+		
Sodium Thiosulphate	cold saturated, aqueous	+	+	0	+	–		+	+	+	+	+		

= No Data    – = Not Recommended    0 = Conditionally Resistant    + = Resistant

# Guide to chemical resistance

	Material °C Concentration	PVCu			ABS			EPDM			FKM			
		20	40	60	20	40	60	20	40	60	20	60	100	120
Spirits (Brandy)	usual commercial	+	+	+	-			+	+	+	+	+		
Stannous Chloride	cold saturated, aqueous	+	0	0	+	+		+	0	-	+	+		
Starch Solution	all, aqueous	+	+	+	+	+		+	+	+	+	+		
Stearic Acid	technically pure	+	+	+	+	+		+	+	0	+	0		
Succinic Acid	all, aqueous	+	+	+				+	+	+	+	+		
Sugar Syrup	usual commercial	+	+	0	+	+	+	+	+	+	+	+		
Sulphur	technically pure	0	-		-			-			+	+		
Sulphur Dioxide	all, moist,	+	+	0	-			+	+	0	+	-		
	technically pure, liquid	-			-			0			0			
Sulphur Trioxide		-			-			-			+			
Sulphuric Acid	up to 30%, aqueous	+	+	0	+	+	0	+	+	+	+	+	-	
	up to 50%, aqueous	+	+	+	+	0	-	+	+	0	+	+		
	up to 80%, aqueous	+	+	+	-			+	0	-	+	0		
	up to 90%, aqueous	+	+		-			0	-		+			
	up to 96%, aqueous	+	+	0	-			-			+			
Sulphurous Acid	saturated, aqueous	+	+	0	-			+	0	-	+	0		
Tallow	technically pure	+	+	+	+	+		+	+	+	+	+		
Tannic Acid	all, aqueous	+			+	+		+			+			
Tartaric Acid	all, aqueous	+	+	0	+	+		+	0	-	+	+		
Tetrachloroethane	technically pure	-			-			-			0			
Tetraethyl Lead	technically pure	+			-			0			+			
Tetrahydrofurane	technically pure	-			-			-			-			
Thionyl Chloride	technically pure	-			-			-			-			
Toluene	technically pure	-			-			-			0	-		
Tributylphosphate	technically pure	-			-			+			-			
Trichloroethylene	technically pure	-			-			-			+			
Trichloroacetic Acid	50%, aqueous	+	0		-			0			-			
Trichloroethane (Methylchloroform)	technically pure	-			-			-			+			
1,2,2-Trifluoroethane (Freon 113)	technically pure	+	+					-			+			
Tricesyl Phosphate	technically pure	-			-			-			-			
Triethanolamine	technically pure	0			-			-			+			
Triethylamine	technically pure				+			-						
Triocetyl Phosphate	technically pure	-			-			-			-			
Turpentine Oil	technically pure	+	0		-			-			+	+		
Urea		+	+	0	-			+	+	+	+	+		
Urine		+	+	0	+	+		+	+	+	+	+		
Vegetable Oils And Fats		+	0		+	+		-			+	+		
Vinegar		+	+	+	+	+	+	+	0	-	0	-		
Vinyl Acetate		-			+	+	0	+			+			
Vinyl Chloride		-			-			0			+			
Waste Gases, Alkaline		+	+	+	-			+	+	+	+	+	-	
Waste Gases Containing:														
- Carbon Oxides	all	+	+	+				+	+	+	+	+	+	
- Hydrochloric Acid	all	+	+	+				+	+	+	+	+	+	
- Hydrogen Fluoride	traces	+	+	+				+	+	0	+	+		
- Nitrous Gases	traces	+	+	+				+	+	+	+	+	0	
- Sulphur Dioxide	traces	+	+	+				+	+	+	+	+		
- Sulphur Trioxide	traces	+	+	+				+	+	+	+	+		
- Sulphuric Acid	all	+	+	+				+	+	+	+	+		
Water, Condensed		+	+	0	+	+	+	+	+	0	+	+		
Water, Distilled, De-Ionised		+	+	+	+	+	+	+	+	0	+	+	+	+
Water, Drinking		+	+	+	+	+	+	+	+	0	+	+	+	
Wax Alcohol	technically pure	+	+	+	-			-			+	+		
Wetting Agents	up to 5%, aqueous	+	+	0	+			+			+			
Wines, Red And White	usual commercial	+			+	+	+	+			+			
Wine Vinegar	usual commercial	+	+	+	+	+		+	0		0	-		
Yeast	all, aqueous	+	+		+			+	+		+			
Xylene	technically pure	-			-			-			+	-		
Zinc Salts	all, aqueous	+	+	0	+	+		+	+	+	+	+		

= No Data    -- = Not Recommended    0 = Conditionally Resistant    + = Resistant



## Support under pressure

When it comes to our plastic pressure systems, you not only get a wide choice of materials, but quality valves designed to maintain optimum flow rates. What's more you'll have the dedicated support of our sales and technical teams at every stage of your project.



## Quality under pressure

Our innovative range of plastic pressure systems come with the widest range of materials and choice of valves designed to maintain optimum flow rates. What's more, they consistently achieve quality approvals, including WRAS and BSI Kitemarks.



## Performance under pressure

You can depend on our plastic pressure systems for a wide choice of high performance materials and valves. Plus, with our national network, we can deliver next day\*.

\*On orders submitted on a working day before 5pm

That's **Polypipe Effast**







